



TVS/ESD Arrays

RLSO8A2.88LC Series

TVS/ESD Arrays - RLSO8A2.88LC Series

Features

- 600 Watts Peak Pulse Power per Line (tp = 8/20µs)
- Working voltages: 2.8V
- Low Leakage Current
- Low operating and clamping voltages
- Lead Free/RoHS compliant
- Solid-state silicon avalanche technology
- Provides ESD protection to IEC61000-4-2(ESD):
 - ±15kV (air discharge)
 - ±8kV (contact discharge)



Mechanical Characteristics

- SOIC-08 package
- Molding compound flammability rating: UL 94V-0
- Quantity Per Reel : 500pcs
- Reel Size : 7 inch
- Lead Finish : Lead Free

Applications

- 10/100/1000 Ethernet
- WAN/LAN Equipment
- Switching Systems
- Desktops, Servers, and Notebooks
- Instrumentation
- Base Stations
- Analog Inputs

Pinout and Functional Block Diagram

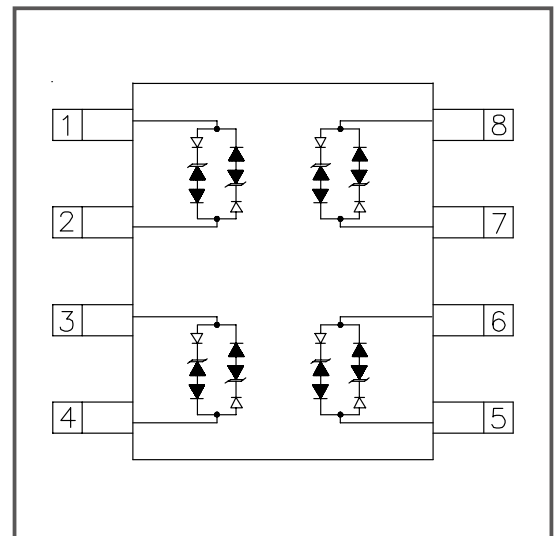

Part Number Code

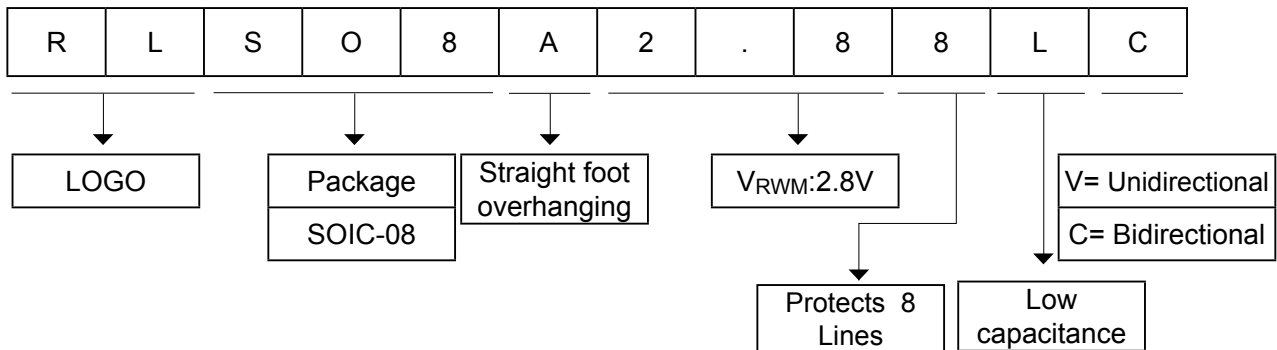

TVS/ESD Arrays - RLSO8A2.88LC Series

Absolute Maximum Rating

Rating	Symbol	Value	Units
Peak Pulse Power (tp =8/20μs)	PPK	600	Watts
ESD Voltage (Contact)	V _{ESD}	±8	Kv
ESD Voltage (Air)	V _{ESD}	±15	Kv
Lead Soldering Temperature	T _L	260 (10 sec.)	°C
Operating Temperature	T _J	-55 to +125	°C
Storage Temperature	T _{STG}	-55 to +150	°C

Electrical Parameters (T=25°C)

Symbol	Parameter
V _{RWM}	Working Peak Reverse Voltage
I _R	Maximum Reverse Leakage Current @ V _{RWM}
V _{BR}	Breakdown Voltage @ I _T
I _T	Test Current
I _F	Forward Current
V _F	Forward Voltage @ I _F

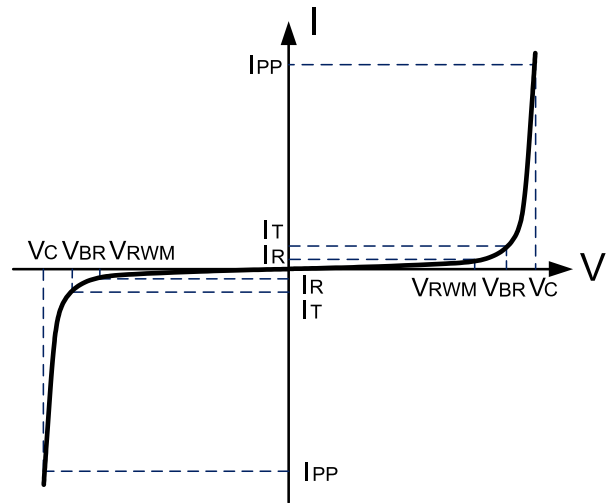

Electrical Characteristics(@ 25°C Unless Otherwise Specified)

Type Number	Reverse Stand-Off Voltage	Minimum Breakdown Voltage	Peak Pulse Voltage @8/20μS	Peak Pulse Current @8/20μS	Reverse Leakage @VRWM	Typical Capacitance
	V _{RWM}	V _{BR@1mA}	V _{C@5A}	I _{PP}	I _{R@VRWM}	C _{J@ 1 MHz}
	V	V	V	A	μA	pF
RLSO8A2.88LC	2.8	3	8.5	30	1	8

TVS/ESD Arrays - RLSO8A2.88LC Series

Characteristic Curves

Fig1. 8/20 μ s Pulse Waveform

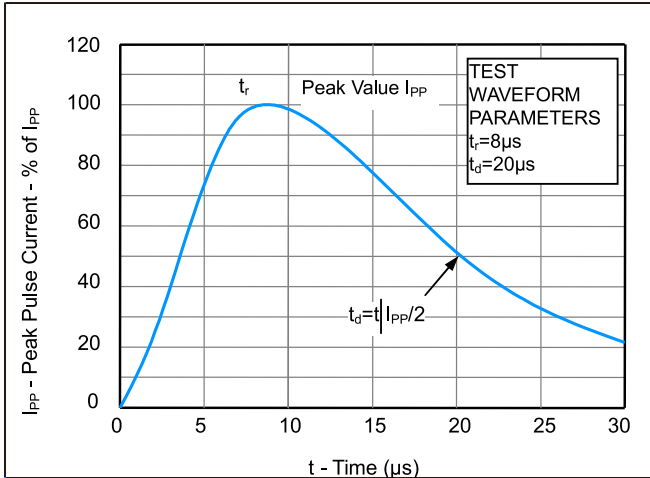

Fig2. ESD Pulse Waveform (according to IEC 61000-4-2)

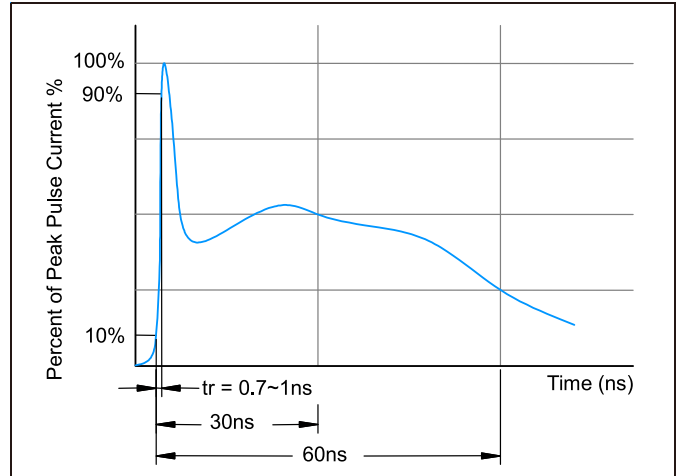

Fig3. Power Derating Curve

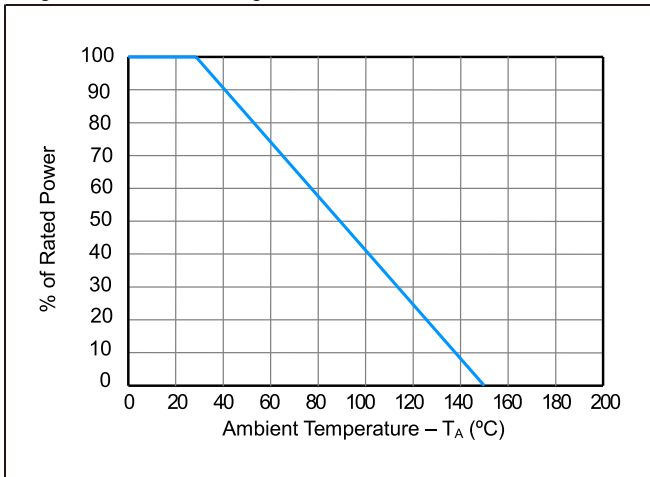
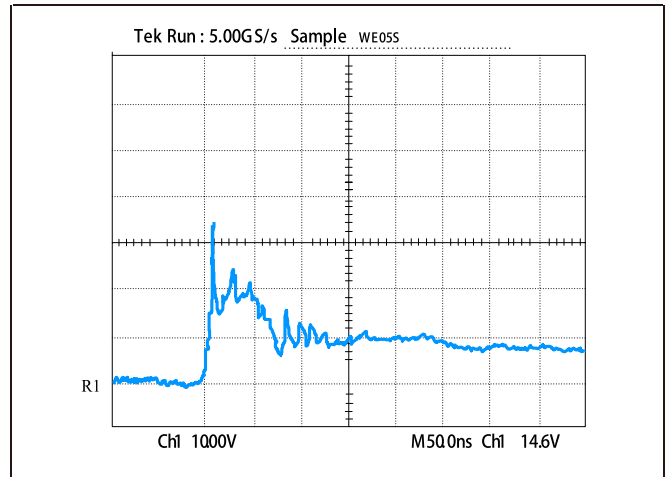
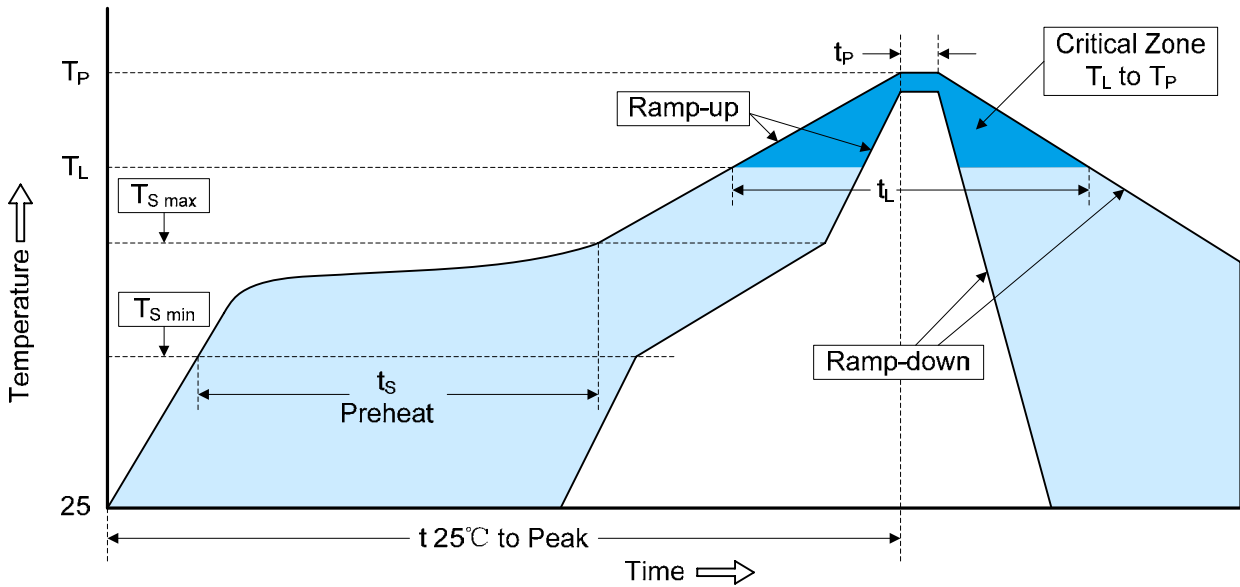

Figure 4: ESD Clamping (8kV Contact per IEC 61000-4-2)



TVS/ESD Arrays - RLSO8A2.88LC Series

Recommended Soldering Conditions



Profile Feature	Pb-Free Assembly
Average ramp-up rate (T_L to T_P)	3°C/second max.
Preheat	150°C
-Temperature Min ($T_{S\ min}$)	200°C
-Temperature Max ($T_{S\ max}$)	60-180 seconds
-Time (min to max) (t_s)	
$T_{S\ max}$ to T_L	3°C/second max.
-Ramp-up Rate	
Time maintained above:	217°C
-Temperature (T_L)	60-150 seconds
-Time (t_L)	
Peak Temperature (T_P)	260°C
Time within 5°C of actual Peak Temperature (t_p)	20-40 seconds
Ramp-down Rate	6°C/second max.
Time 25°C to Peak Temperature	8 minutes max.

TVS/ESD Arrays - RLSO8A2.88LC Series

Package dimension SOIC-08

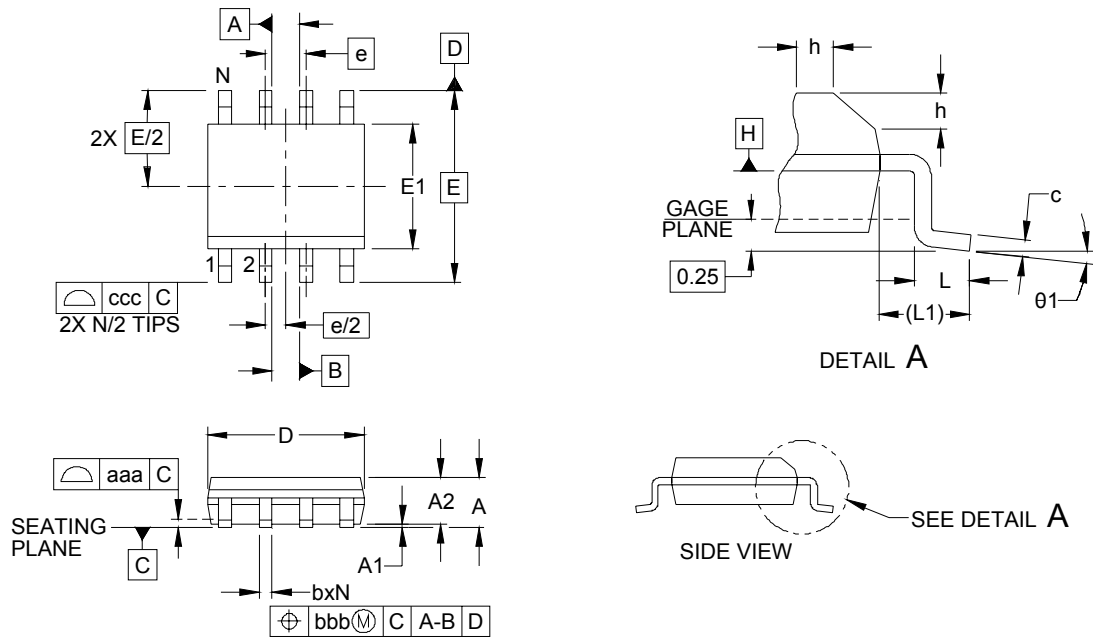

NOTES:

1. CONTROLLING DIMENSIONS ARE IN MILLIMETERS (ANGLES IN DEGREES).
2. DATUMS **-A-** AND **-B-** TO BE DETERMINED AT DATUM PLANE **-H-**
3. DIMENSIONS "E1" AND "D" DO NOT INCLUDE MOLD FLASH, PROTRUSIONS OR GATE BURRS.

Dimensions						
DIM	Inches			Millimeters		
	Min	Nom	Max	Min	Nom	Max
A	0.053	-	0.069	1.35	-	1.75
A1	0.004	-	0.010	0.10	-	0.25
A2	0.049	-	0.065	1.25	-	1.65
b	0.012	-	0.020	0.31	-	0.51
c	0.007	-	0.010	0.17	-	0.25
D	0.189	0.193	0.197	4.80	4.90	5.00
E1	0.150	0.154	0.157	3.80	3.90	4.00
E	0.236 BSC			6.00 BSCBSC		
e	0.050 BSC			1.27BSC		
h	0.010	-	0.20	0.25	-	0.50
L	0.016	0.028	0.40	0.40	0.72	1.04
L1	(0.041)			(1.04)		
N	8			8		
$\theta 1$	0°	-	8°	0°	-	8°
aaa	0.004			0.10		
bbb	0.010			0.25		
ccc	0.008			0.20		