

Features

- 45 Watts peak pulse power ($t_p = 8/20\mu s$)
- Bidirectional and unidirectional configurations
- Solid-state silicon-avalanche technology
- Low clamping voltage
- Low leakage current
- Low capacitance ($C_j = 0.4$ pF typ.)
- Protection two data lines:
- IEC 61000-4-2 $\pm 25V$ contact $\pm 25kV$ air
- IEC 61000-4-4 (EFT) 40A (5/50ns)
- IEC 61000-4-5 (Lightning) 3.5A (8/20 μs)

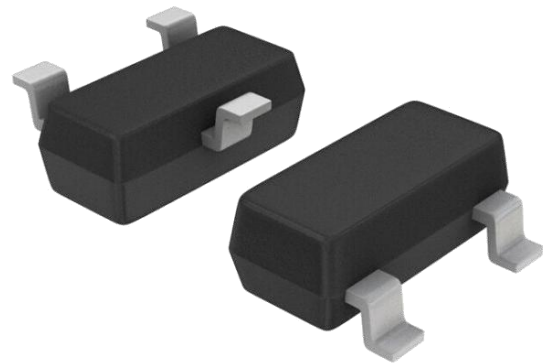

Applications

- Dataline
- Automatic Teller Machines
- Net works
- Power line

Mechanical Data

- SOT-23 package
- Molding compound flammability rating: UL 94V-0
- Packaging: Tape and Reel
- RoHS/WEEE Compliant

Schematic & PIN Configuration

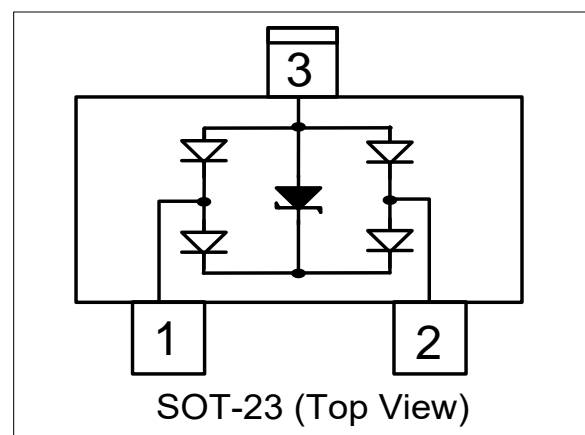
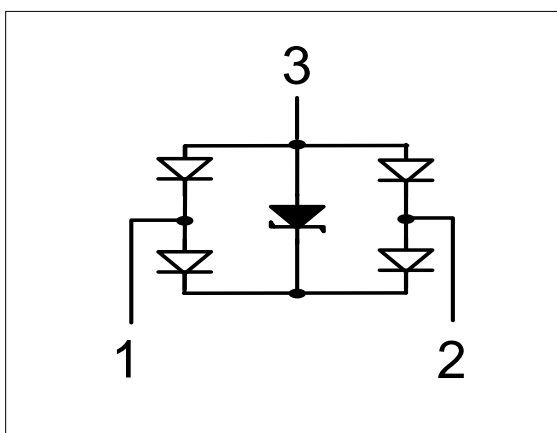

Absolute Maximum Rating

Rating	Symbol	Value	Units
Peak Pulse Power ($t_p = 8/20\mu s$)	P_{PP}	45	Watts
Peak Pulse Current ($t_p = 8/20\mu s$) (note 1)	I_{PP}	3.5	A
ESD per IEC 61000-4-2 (Air) ESD per IEC 61000-4-2 (Contact)	V_{ESD}	25 25	kV
Lead Soldering Temperature	T_L	260(10seconds)	°C
Junction Temperature	T_J	-55 to + 125	°C
Storage Temperature	T_{stg}	-55 to + 125	°C

Electrical Characteristics

Parameter	Symbol	Conditions	Min	Typical	Max	Units
Reverse Stand-Off Voltage	V_{RWM}				5	V
Reverse Breakdown Voltage	V_{BR}	$I_T = 1mA$	6			V
Reverse Leakage Current	I_R	$V_{RWM} = 5V, T = 25^\circ C$		0.5	1	μA
Peak Pulse Current	I_{PP}	$t_p = 8/20\mu s$			3.5	A
Clamping Voltage	V_C	$I_{PP} = 3.5A, t_p = 8/20\mu s$		11		V
Junction Capacitance	C_j	$V_R = 0V, f = 1MHz$		0.4		pF

Electrical Parameters (TA = 25°C unless otherwise noted)

Symbol	Parameter
I_{PP}	Maximum Reverse Peak Pulse Current
V_C	Clamping Voltage @ I_{PP}
V_{RWM}	Working Peak Reverse Voltage
I_R	Maximum Reverse Leakage Current @ V_{RWM}
V_{BR}	Breakdown Voltage @ I_T
I_T	Test Current

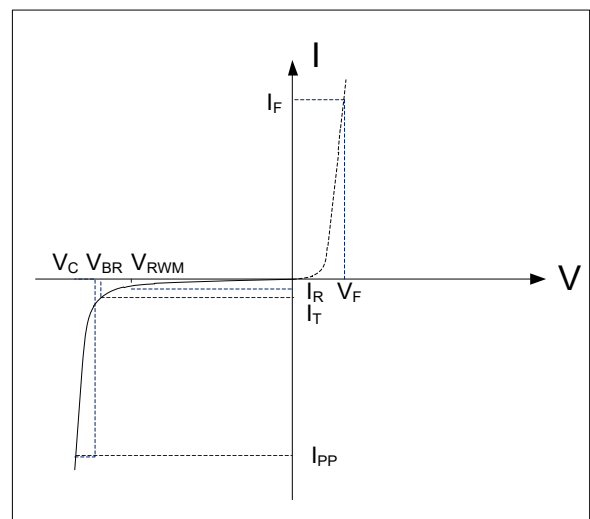

Note: 8/20 μs pulse waveform.



Typical Characteristics

Figure 1: Peak Pulse Power vs. Pulse Time

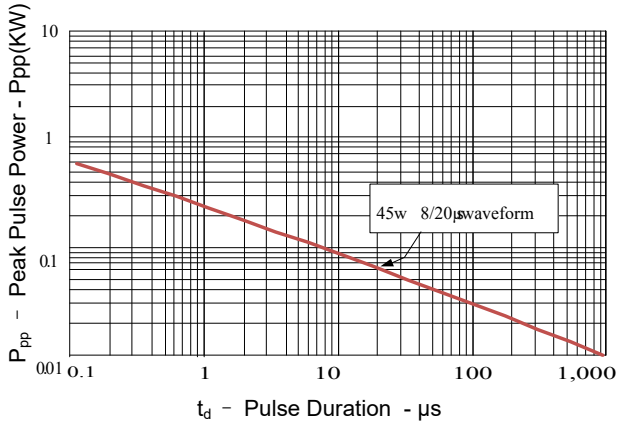

Figure 2: Power Derating Curve

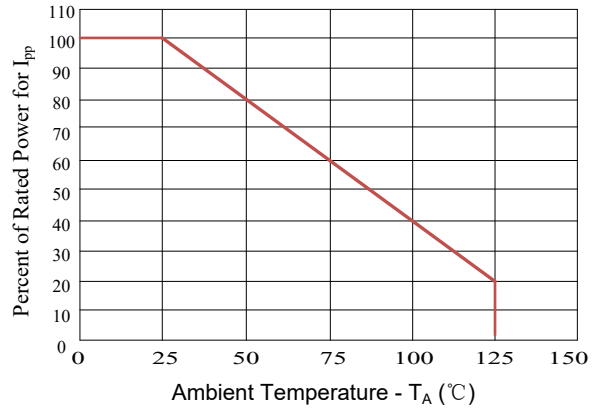

Figure3: Pulse Waveform

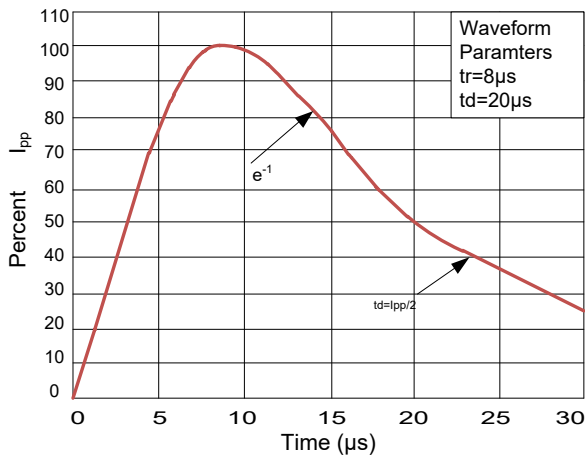
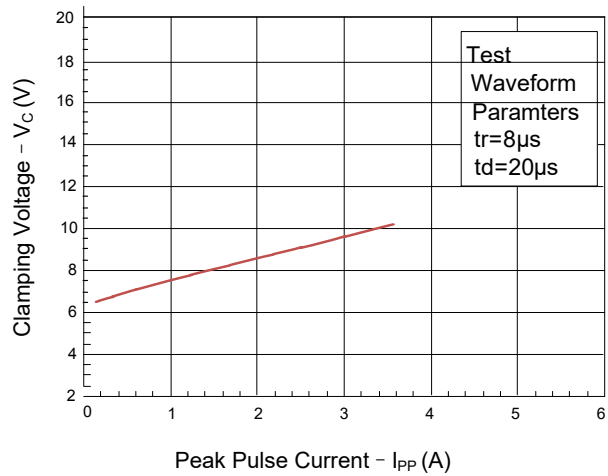
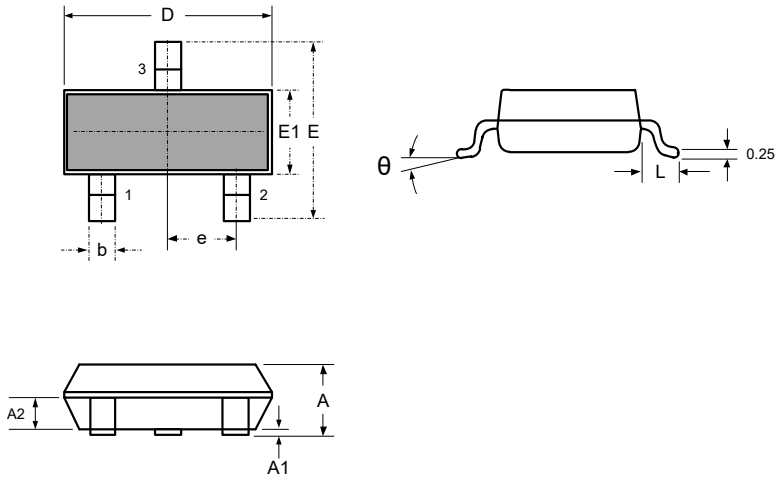
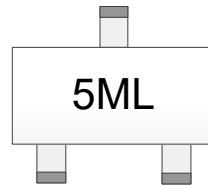

Figure 4: Clamping Voltage vs.Ipp



Outline Drawing – SOT-23

DIMENSIONS

SYMBOL	MILLIMETER		INCHES	
	MIN	MAX	MIN	MAX
A	0.900	1.150	0.035	0.045
A1	0.000	0.100	0.000	0.004
A2	0.900	1.050	0.035	0.041
D	2.800	3.000	0.110	0.118
b	0.300	0.500	0.012	0.020
E	2.250	2.550	0.089	0.100
E1	1.200	1.400	0.047	0.055
e	0.950 BSC		0.037 BSC	
L	0.300	0.500	0.012	0.020
θ	0	8°	0	8°

Marking

Ordering information

Order code	Package	Base qty	Delivery mode
RLST23A052UV	SOT-23	3k	Tape and reel

