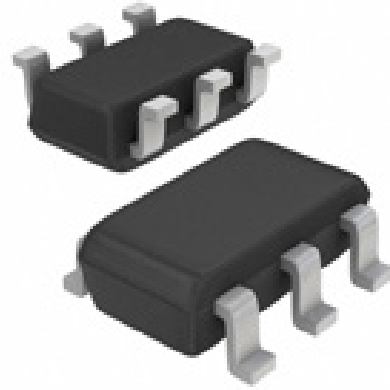


## Features

- 30Watts peak pulse power ( $t_p = 8/20\mu s$ )
- SOT23-6 package
- Solid-state silicon-avalanche technology
- Low clamping voltage
- Low leakage current
- Low capacitance ( $C_j = 0.2pF$  typ.)
- Protection one data/power line to:
- IEC 61000-4-2  $\pm 12kV$  contact  $\pm 15kV$  air
- IEC 61000-4-4 (EFT) 40A (5/50ns)
- IEC 61000-4-5 (Lightning) 3A (8/20 $\mu s$ )



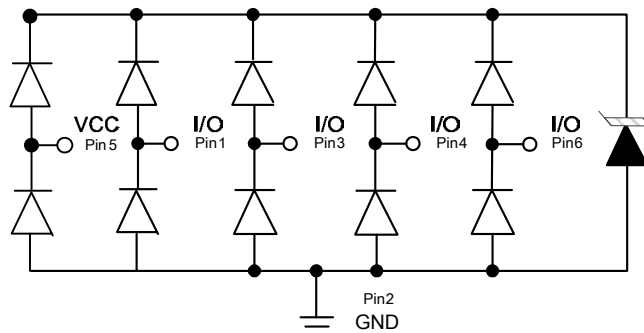
## Applications

- Ethernet
- Digital Visual Interface (DVI)
- USB2.0
- Notebook and PC Computers

## Mechanical Data

- SOT23-6 package
- Molding compound flammability rating: UL 94V-0
- Packaging: Tape and Reel
- RoHS/WEEE Compliant

## Schematic & PIN Configuration



### Absolute Maximum Rating

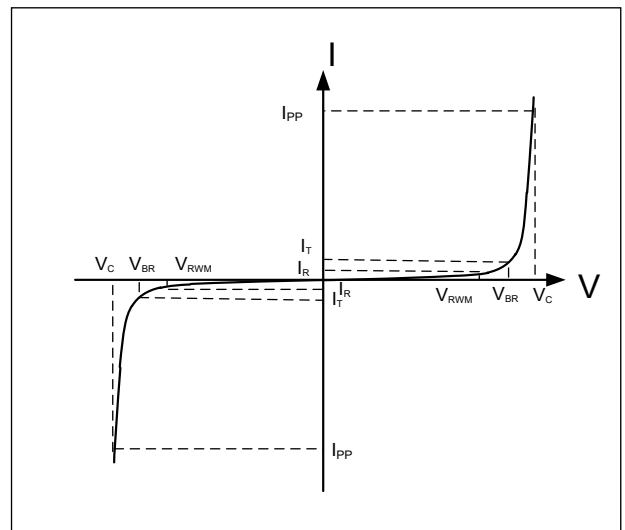
Rating	Symbol	Value	Units
Peak Pulse Power ( $t_p = 8/20\mu s$ )	$P_{PP}$	30	Watts
Peak Pulse Current ( $t_p = 8/20\mu s$ ) (note1)	$I_{pp}$	3	A
ESD per IEC 61000-4-2 (Air) ESD per IEC 61000-4-2 (Contact)	$V_{ESD}$	15 12	kV
Lead Soldering Temperature	$T_L$	260(10seconds)	°C
Junction Temperature	$T_J$	-55 to + 125	°C
Storage Temperature	$T_{stg}$	-55 to + 125	°C

### Electrical Characteristics

Parameter	Symbol	Conditions	Min	Typical	Max	Units
Reverse Stand-Off Voltage	$V_{RWM}$				5.0	V
Reverse Breakdown Voltage	$V_{BR}$	$I_T = 1mA$	6	7.2		V
Reverse Leakage Current	$I_R$	$V_{RWM} = 5V, T = 25^\circ C$		50	500	nA
Peak Pulse Current	$I_{pp}$	$t_p = 8/20\mu s$			3	A
Clamping Voltage	$V_C$	$I_{pp} = 3A, t_p = 8/20\mu s$		9	10	V
Junction Capacitance	$C_j$	$V_R = 0V, f = 1MHz$ IO to IO		0.2	0.25	pF
		$V_R = 0V, f = 1MHz$ IO to GND		0.35	0.4	

### Electrical Parameters (TA = 25°C unless otherwise noted)

Symbol	Parameter
$I_{PP}$	Maximum Reverse Peak Pulse Current
$V_C$	Clamping Voltage @ $I_{PP}$
$V_{RWM}$	Working Peak Reverse Voltage
$I_R$	Maximum Reverse Leakage Current @ $V_{RWM}$
$V_{BR}$	Breakdown Voltage @ $I_T$
$I_T$	Test Current

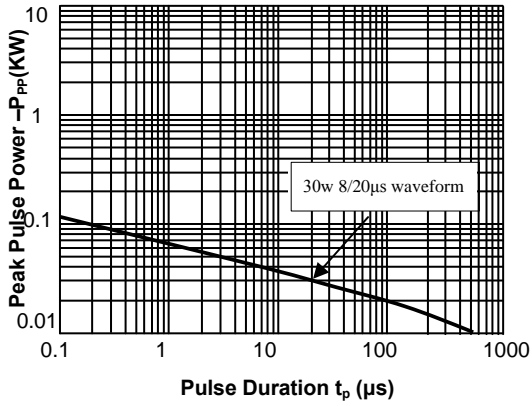


Note: 8/20μs pulse waveform.

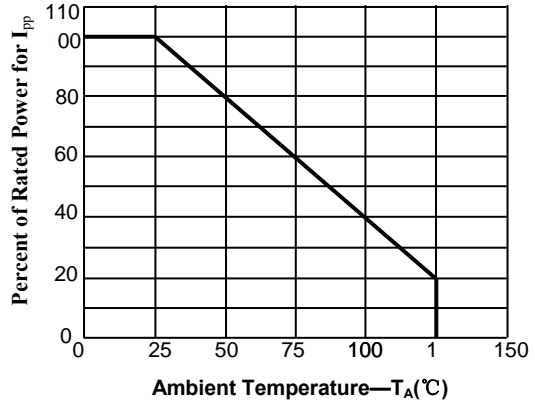


**Typical Characteristic Curves**

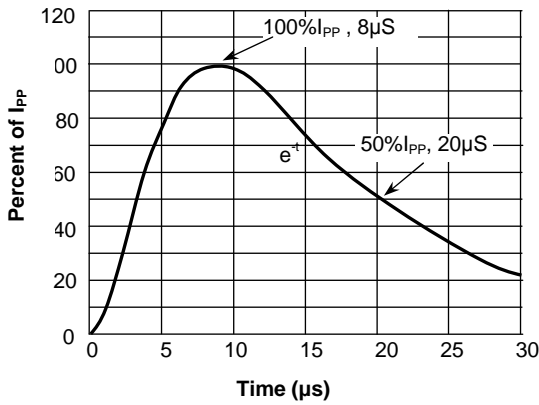
**Fig.1 Peak Pulse Power Rating Curve**



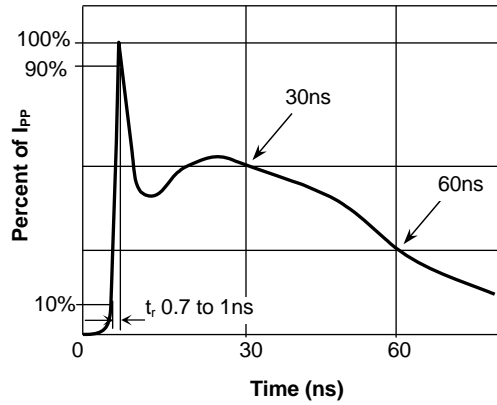
**Fig.2 Pulse Derating Curve**



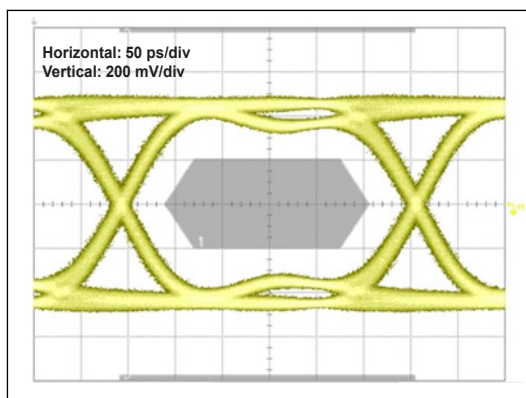
**Fig.3 Pulse Waveform-8/20μs**



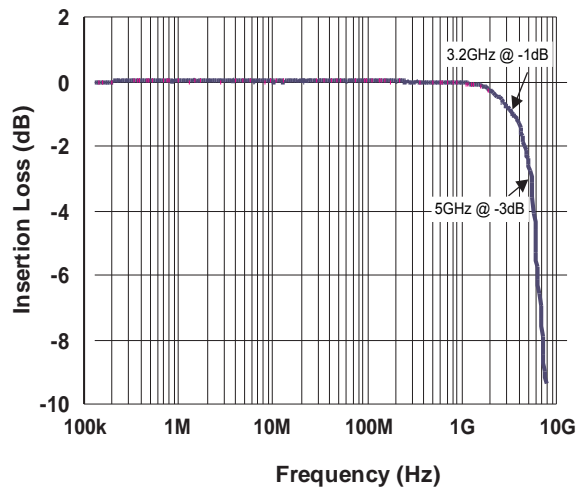
**Fig.4 Pulse Waveform-ESD(IEC61000-4-2)**

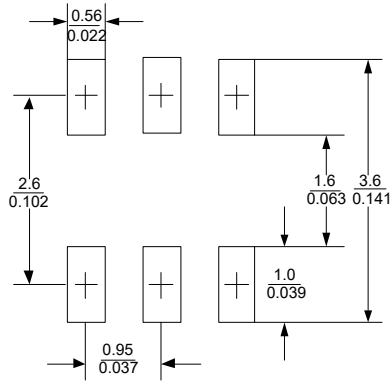
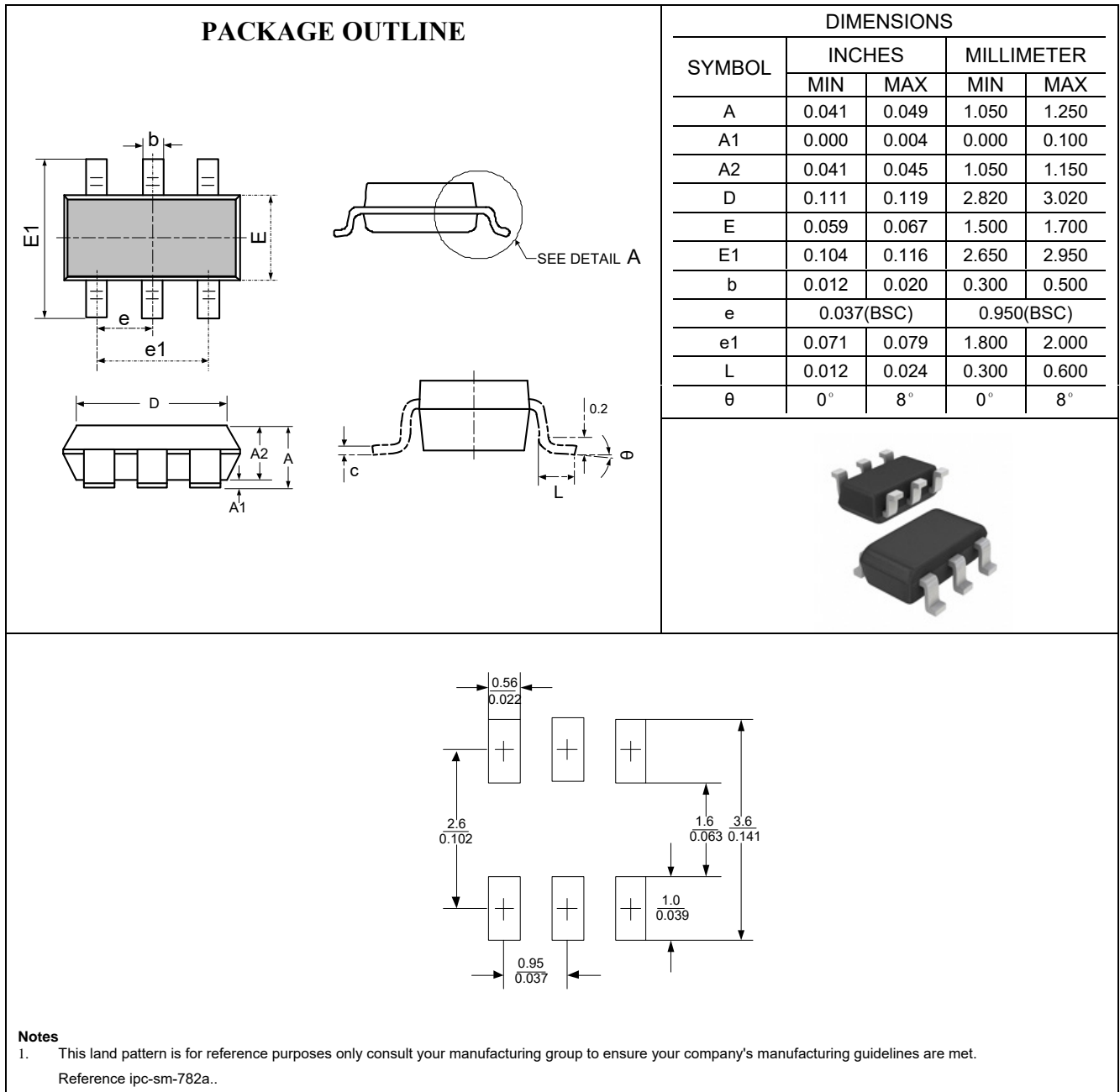
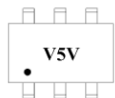


**Fig.5 Eye Diagram - HDMI mask at 5.0Gbps per channel**



**Fig.6 Insertion Loss S21 - I/O to GND**



**Outline Drawing – SOT23-6**

**Marking**

**Ordering information**

Order code	Package	Base qty	Delivery mode
RLST236A054UV	SOT23-6	3k	Tape and reel

