

Features

- | 130 Watts Peak Pulse Power per Line (tp = 8/20µs)
- | Working voltages: 5V
- | Low Leakage Current
- | Low operating and clamping voltages
- | Lead Free/RoHS compliant
- | Solid-state silicon avalanche technology
- | Provides ESD protection to IEC61000-4-2(ESD): ±25kV (air discharge), ±25kV (contact discharge)

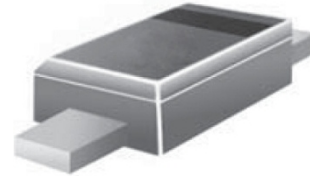

SOD-523

Electrical symbol

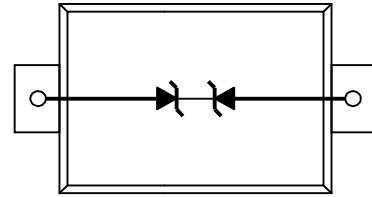

Applications

- | Cell Phone Handsets and Accessories
- | Microprocessor based equipment
- | Personal Digital Assistants (PDA's)
- | Notebooks, Desktops, and Servers
- | Portable Instrumentation
- | Pagers Peripherals

Part Number Code

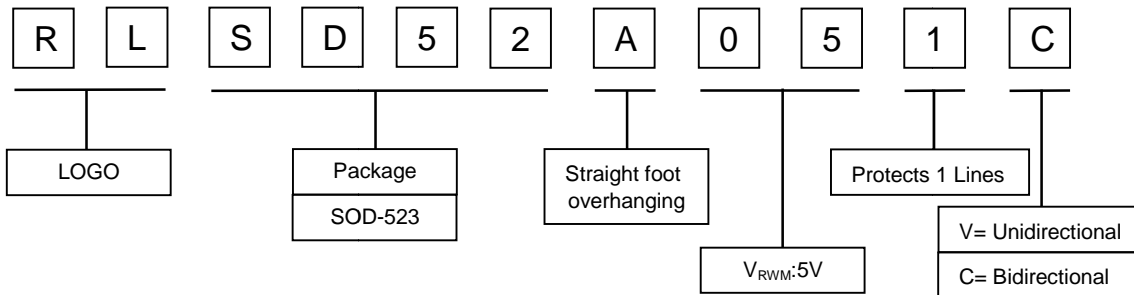

Absolute Maximum Rating

Rating	Symbol	Value	Units
Peak Pulse Power (tp =8/20µs)	P _{PP}	130	Watts
ESD Voltage (Contact)	V _{ESD}	±25	kV
ESD Voltage (Air)	V _{ESD}	±25	kV
Lead Soldering Temperature	T _L	260 (10 sec.)	°C
Operating Temperature Range	T _{OP}	-55 to 150	°C
Storage Temperature	T _{STG}	-55 to 155	°C

Electrical Characteristics (@ 25°C Unless Otherwise Specified)

Type Number	Reverse Stand-Off Voltage	Minimum Breakdown Voltage	Peak Pulse Voltage @8/20µS	V _C @8/20µS		Reverse Leakage @V _{RWM}	Typical Capacitance
	V _{RWM}	V _{BR} @1mA	V _C @5A	(max.)	@I _{PP}	I _R @V _{RWM}	DC=0V C _J @ 1 MHz
	V	V	V	V	A	µA	pF
RLSD52A051C	5.0	5.5	12.5	15	9	1.0	15



Electrical Parameters (T=25°C)

Symbol	Parameter
I_{PP}	Maximum Reverse Peak Pulse Current
V_C	Clamping Voltage @ I_{PP}
V_{RWM}	Working Peak Reverse Voltage
I_R	Maximum Reverse Leakage Current @ V_{RWM}
V_{BR}	Breakdown Voltage @ I_T
I_T	Test Current

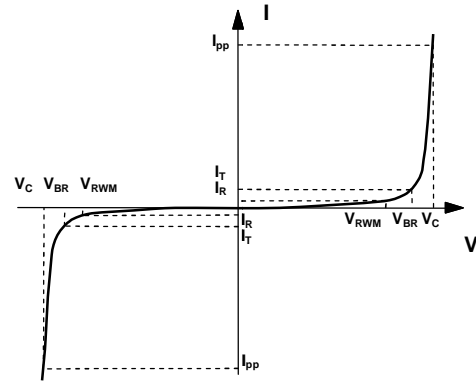

Characteristic Curves

Fig 1. 8/20µs Pulse Waveform

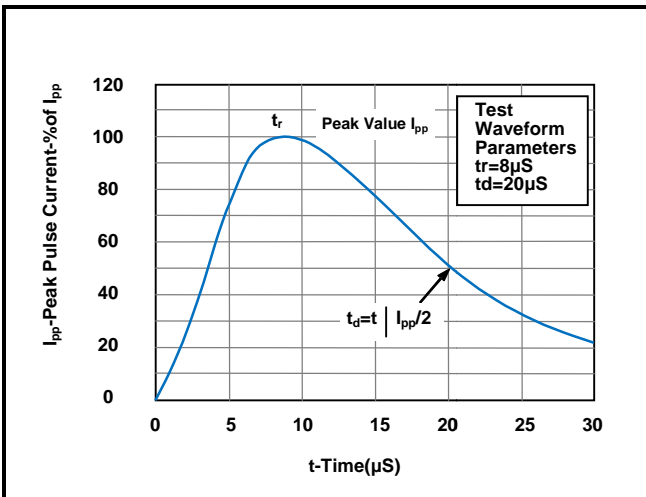

Fig 3. Power Derating Curve

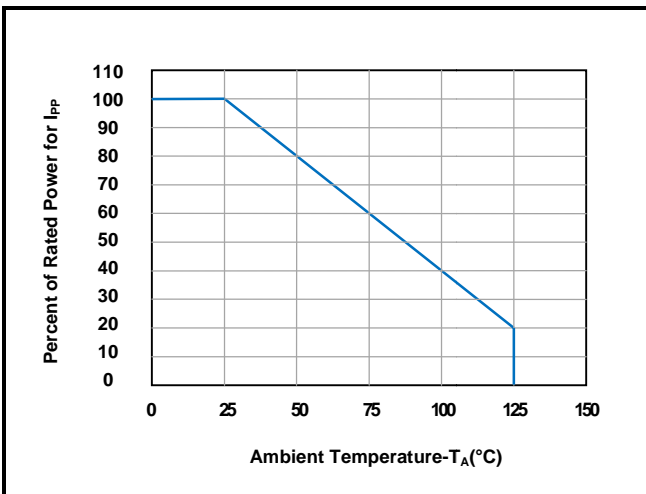

Fig2.ESD Pulse Waveform (according to IEC61000-4-2)

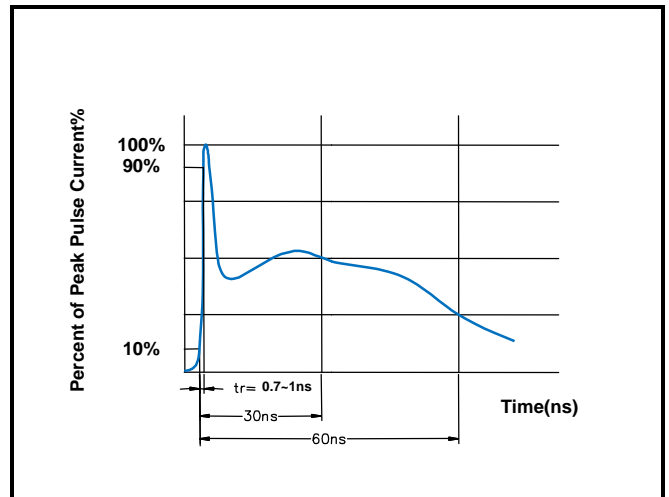
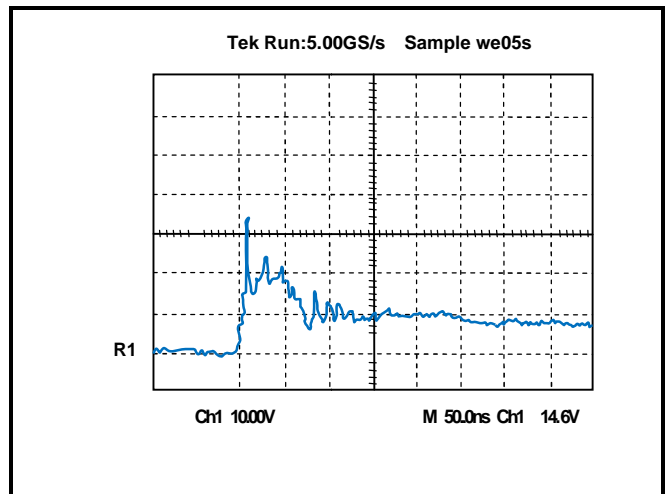
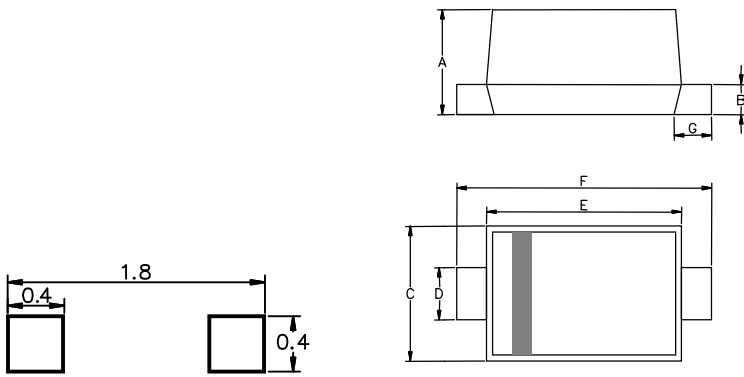

Figure 4.ESD Clamping(8KV Contact per IEC61000-4-2)



Dimensions & Recommended soldering footprint(mm)



DIM	Millimeters		Inches	
	Min	Max	Min	Max
A	0.5	0.7	0.020	0.028
B	0.07	0.2	0.003	0.008
C	0.7	0.9	0.028	0.035
D	0.25	0.35	0.010	0.014
E	1.1	1.3	0.043	0.051
F	1.5	1.7	0.059	0.067
G	0.15	0.25	0.006	0.010

Part Number	Marking	Component package	Quantity	Reel Size	Molding compound flammability rating	Lead Finish
RLSD52A051C	5C	SOD-523	3000	7 inch	UL 94V-0	Lead Free

Soldering Parameters - Reflow Soldering (Surface Mount Devices)

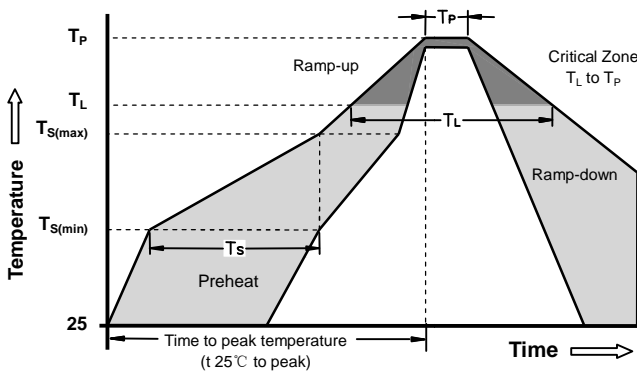

Reflow Condition		Pb - Free assembly
Pre Heat	-Temperature Min ($T_{s(min)}$)	150°C
	-Temperature Max ($T_{s(max)}$)	200°C
	- Time (min to max) (t_s)	60 - 180 Seconds
Average ramp up rate (Liquids Temp T_L to peak)		3°C/second max
$T_{s(max)}$ to T_L - Ramp-up Rate		3°C/second max
Reflow	- Temperature (T_L) (Liquids)	217°C
	- Time (min to max) (t_s)	60 - 150 Seconds
Peak Temperature (T_P)		260 +0/-5°C
Time within 5°C of actual peak Temperature (t_p)		20 - 40 Seconds
Ramp-down Rate		6°C/second max
Time 25°C to peak Temperature (T_P)		8 minutes Max
Do not exceed		280°C

