

Features

- I 180 Watts Peak Pulse Power per Line (tp = 8/20µs)
- I Bidirectional Configuration
- I Protects One Power or I/O Port
- I ESD Protection > 40 kilovolts
- I Low Clamping Voltages
- I Ultra Low Capacitance: 0.8 pF Typical



SOD-323

Electrical symbol

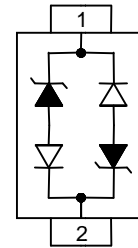

Applications

- I Ethernet - 10/100/1000 Base T
- I Cellular Phones
- I Handheld - Wireless Systems
- I Personal Digital Assistant (PDA)
- I USB Interface

Part Number Code

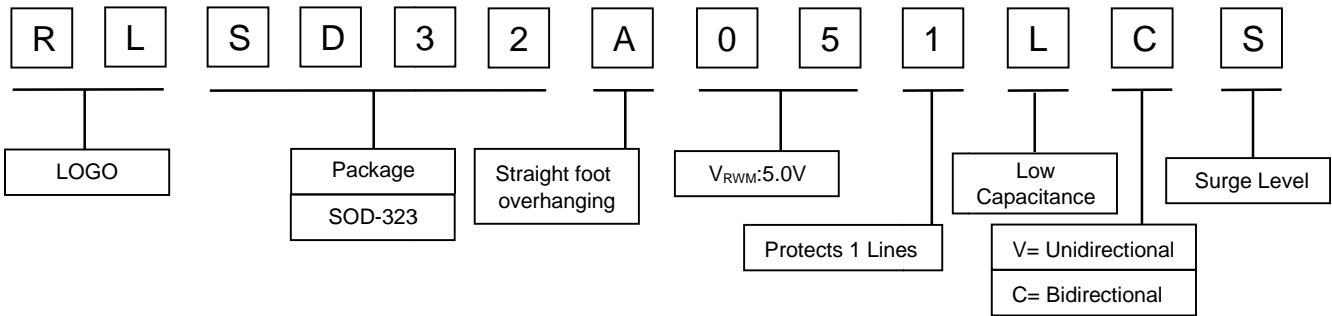

Absolute Maximum Rating

Rating	Symbol	Value	Units
Peak Pulse Power (tp =8/20µs)	P _{PP}	180	Watts
ESD Voltage (Contact)	V _{ESD}	±8	kV
ESD Voltage (Air)	V _{ESD}	±15	kV
Operating Temperature	T _J	-55 to 150	°C
Storage Temperature	T _{STG}	-55 to 150	°C

Electrical Characteristics (@ 25°C Unless Otherwise Specified)

Type Number	Reverse Stand-Off Voltage	Minimum Breakdown Voltage	Peak Pulse Voltage @8/20µS	V _C @8/20µS		Reverse Leakage @V _{RWM}	Typical Capacitance
	V _{RWM}	V _{BR} @1mA	V _C @1A	(max.)	@I _{PP}	I _R @V _{RWM}	DC=0V C _J @ 1 MHz
	V	V	V	V	A	µA	pF
RLSD32A051LCS	5.0	6.0	8.0	15	12	0.1	0.8



Electrical Parameters (T=25°C)

Symbol	Parameter
I_{PP}	Maximum Reverse Peak Pulse Current
V_C	Clamping Voltage @ I_{PP}
V_{RWM}	Working Peak Reverse Voltage
I_R	Maximum Reverse Leakage Current @ V_{RWM}
V_{BR}	Breakdown Voltage @ I_T
I_T	Test Current
I_F	Forward Current
V_F	Forward Voltage @ I_F

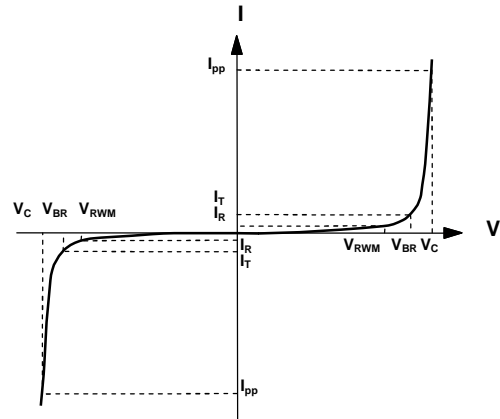

Characteristic Curves

Fig 1. 8/20µs Pulse Waveform

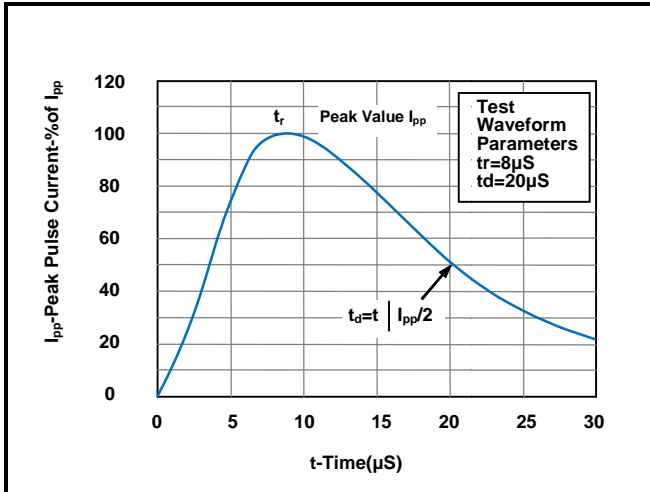

Fig 3. Power Derating Curve

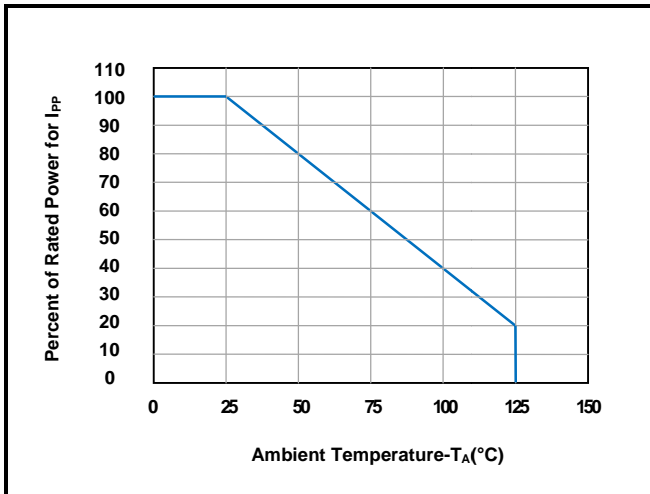

Fig2.ESD Pulse Waveform (according to IEC61000-4-2)

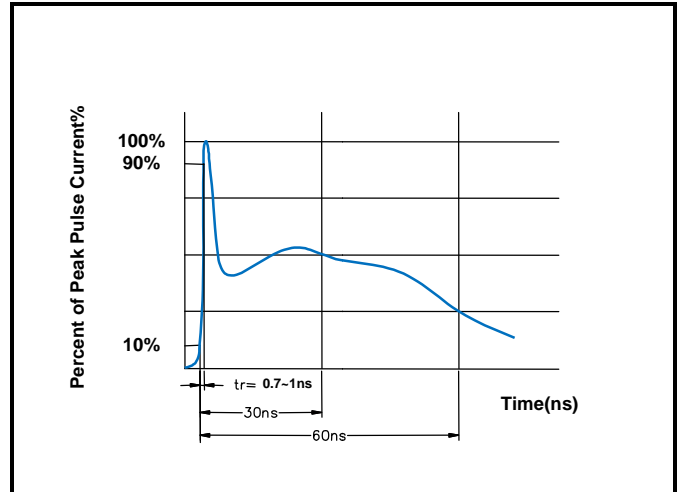
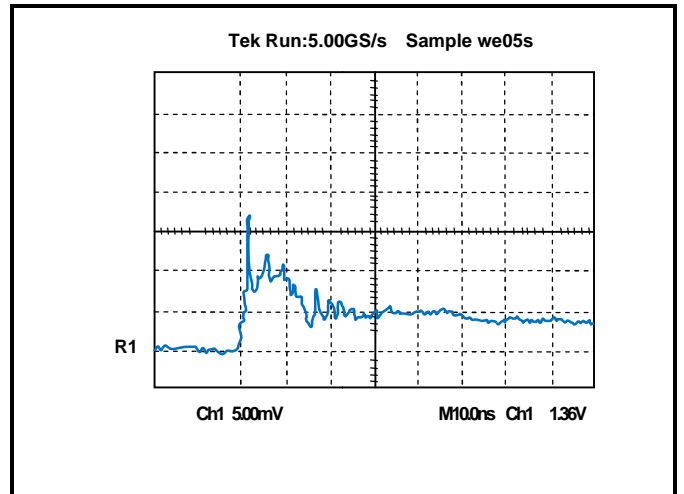
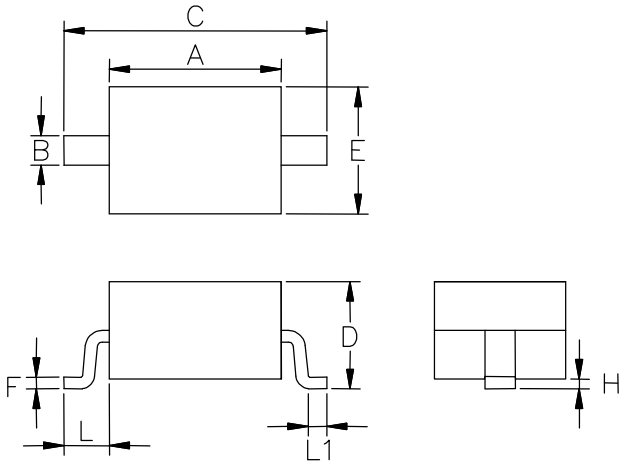

Figure 4.ESD Clamping(8KV Contact per IEC61000-4-2)



Dimensions



DIM	Millimeters		Inches	
	Min	Max	Min	Max
A	1.60	1.80	0.063	0.071
B	0.25	0.35	0.010	0.014
C	2.50	2.70	0.098	0.106
D	0.00	1.00	0.00	0.039
E	1.20	1.40	0.047	0.055
F	0.08	0.15	0.003	0.006
L	0.475REF		0.019REF	
L1	0.25	0.40	0.010	0.016
H	0.00	0.10	0.00	0.004

Part Number	Component package	Quantity	Reel Size	Molding compound flammability rating	Lead Finish
RLSD32A051LCS	SOD-323	3000	7 inch	UL 94V-0	Lead Free

Mounting PAD (mm)

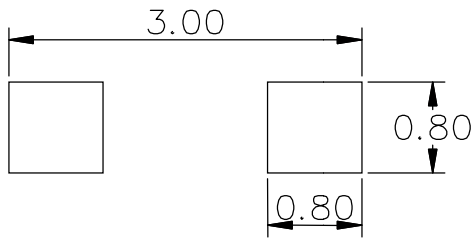

Soldering Parameters - Reflow Soldering (Surface Mount Devices)

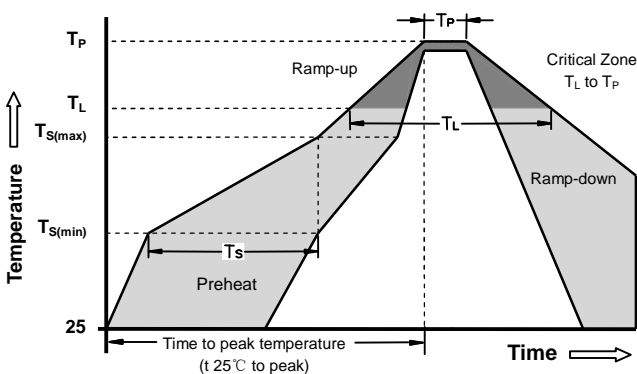

Reflow Condition		Pb - Free assembly
Pre Heat	-Temperature Min ($T_{S(min)}$)	150°C
	-Temperature Max ($T_{S(max)}$)	200°C
	- Time (min to max) (t_s)	60 -180 Seconds
Average ramp up rate (Liquids Temp T_L) to peak		3°C/second max
$T_{S(max)}$ to T_L - Ramp-up Rate		3°C/second max
Reflo w	- Temperature (T_L) (Liquids)	217°C
	- Time (min to max) (t_s)	60 -150 Seconds
Peak Temperature (T_P)		260 +0/-5°C
Time within 5°C of actual peak Temperature (t_p)		20 - 40 Seconds
Ramp-down Rate		6°C/second max
Time 25°C to peak Temperature (T_P)		8 minutes Max
Do not exceed		280°C

