

Features

- 56Watts peak pulse power ($t_p = 8/20\mu s$)
- Bidirectional configurations
- Solid-state silicon-avalanche technology
- Low clamping voltage
- Low leakage current
- IEC 61000-4-2 $\pm 15kV$ contact $\pm 18kV$ air
- IEC 61000-4-4 (EFT) 40A (5/50ns)
- IEC 61000-4-5 (Lightning) 7A (8/20 μs)

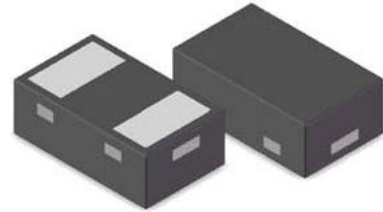

Applications

- Cell Phone Handsets and Accessories
- Microprocessor based equipment
- Personal Digital Assistants (PDA' s)
- Notebooks, Desktops, and Servers
- Portable Instrumentation

Mechanical Data

- DFN0603 package
- Molding compound flammability rating: UL 94V-0
- Packaging: Tape and Reel
- RoHS/WEEE Compliant

Schematic & PIN Configuration

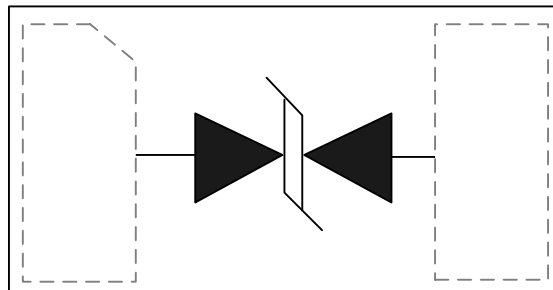

DFN0603



Absolute Maximum Rating

Rating	Symbol	Value	Units
Peak Pulse Power ($t_p = 8/20\mu s$)	P_{PP}	56	Watts
Peak Pulse Current ($t_p = 8/20\mu s$) (note1)	I_{pp}	7	A
ESD per IEC 61000-4-2 (Air) ESD per IEC 61000-4-2 (Contact)	V_{ESD}	18 15	kV
Lead Soldering Temperature	T_L	260(10seconds)	°C
Junction Temperature	T_J	-55 to + 125	°C
Storage Temperature	T_{stg}	-55 to + 125	°C

Electrical Characteristics

Parameter	Symbol	Conditions	Min	Typical	Max	Units
Reverse Stand-Off Voltage	V_{RWM}				18.0	V
Holding Voltage	V_H	$I_T = I_H$		2.5		V
Holding Current	I_H		35			mA
Reverse Leakage Current	I_R	$V_{RWM} = 18V, T = 25^\circ C$			500	nA
Clamping Voltage	V_C	$I_{PP} = 7A, t_p = 8/20\mu s$			8	V
Trigger Voltage	V_T			22		V
Junction Capacitance	C_j	$V_R = 0V, f = 1MHz$		0.6		pF

Electrical Parameters (TA = 25°C unless otherwise noted)

Symbol	Parameter
I_{PP}	Maximum Reverse Peak Pulse Current
V_C	Clamping Voltage @ I_{PP}
V_{RWM}	Working Peak Reverse Voltage
I_R	Maximum Reverse Leakage Current @ V_{RWM}
V_T	Trigger voltage
I_T	Test Current
V_H	Holding voltage
I_H	Holding Current

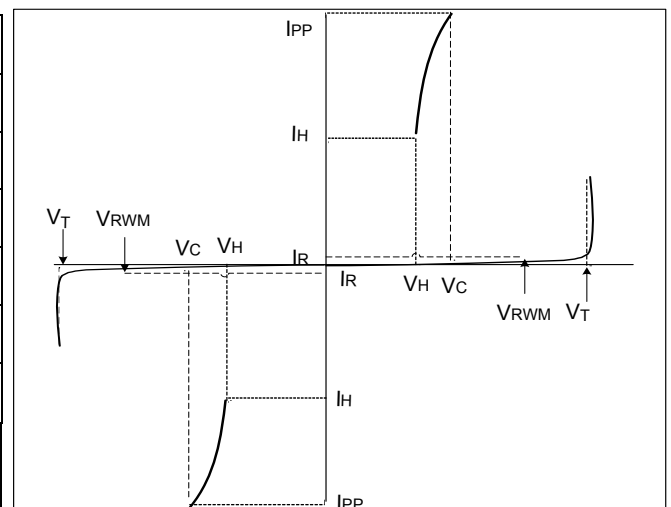

Note: 8/20μs pulse waveform.



Typical Characteristics

Figure 1: Peak Pulse Power vs. Pulse Time

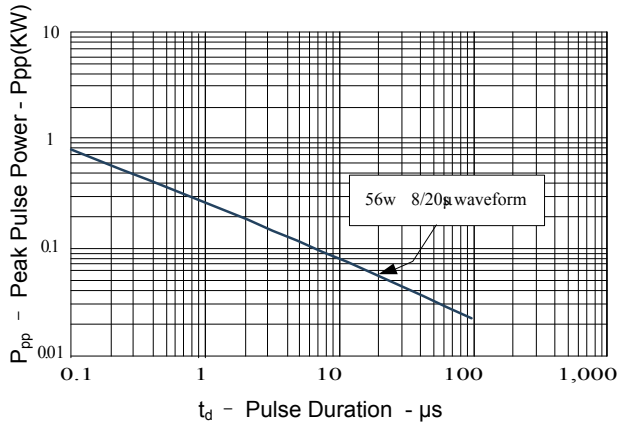

Figure 2: Power Derating Curve

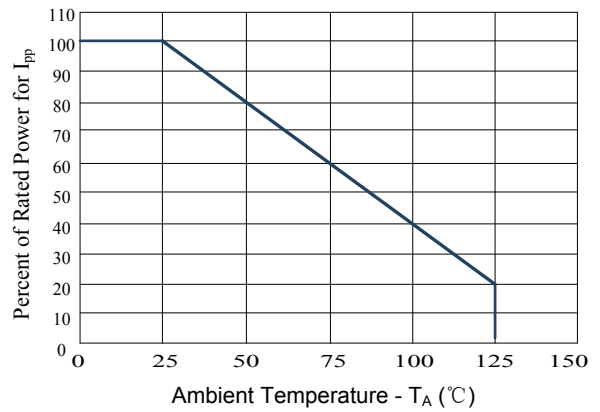

Figure3: Pulse Waveform

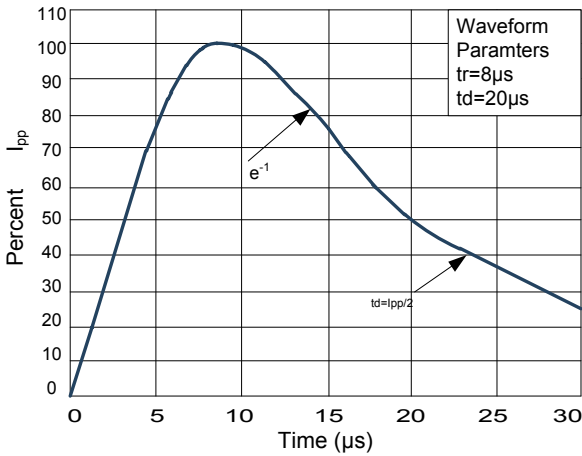

Figure 4: Clamping Voltage vs. I_pp

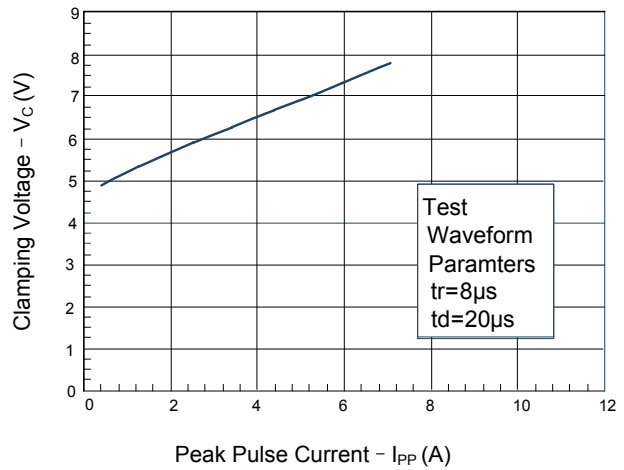

Figure5: Positive Clamping voltage (TLP)

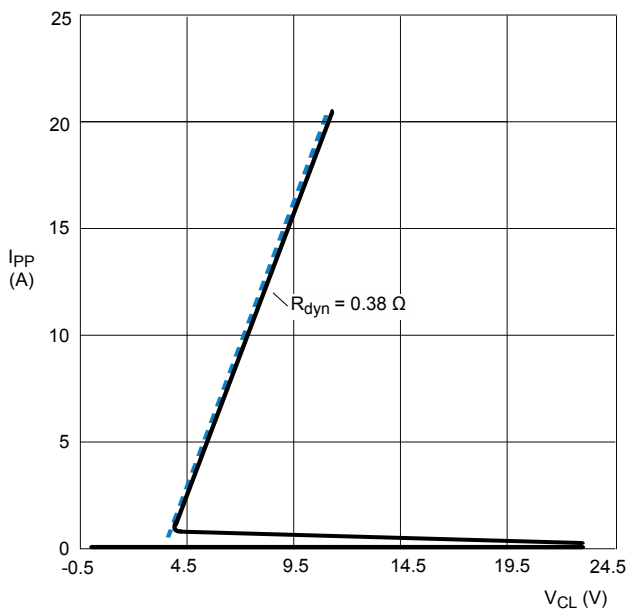
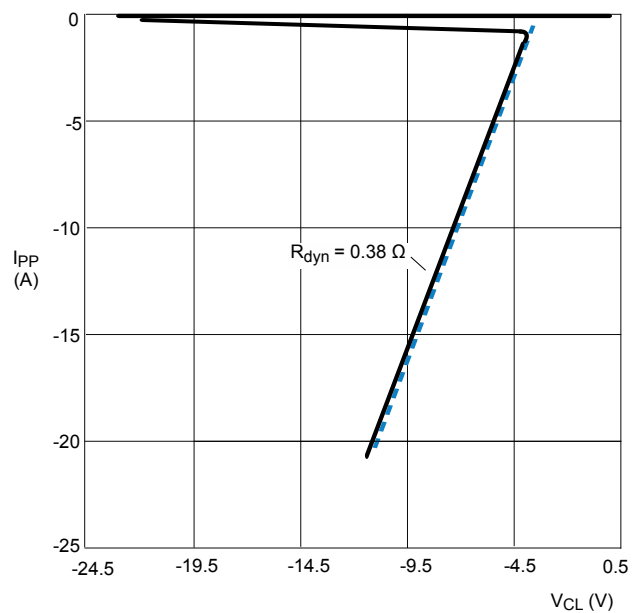
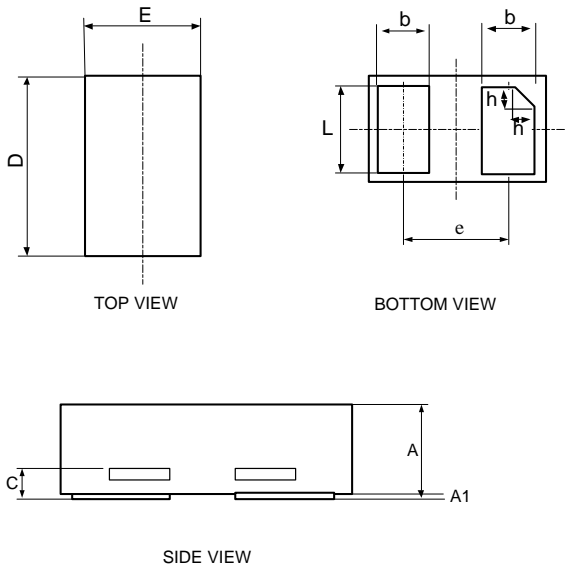

Figure6: Negative Clamping voltage (TLP)



Outline Drawing – DFN0603



Symbol	Dimensions in millimeters		
	Min	Nom	Max
A	0.28	0.30	0.34
A1	0.00	0.02	0.05
C	0.05	0.10	0.15
D	0.55	0.60	0.65
E	0.25	0.30	0.35
e	0.40		
b	0.13	0.19	0.24
L	0.20	0.25	0.30
h	0	0.05	0.10

Marking

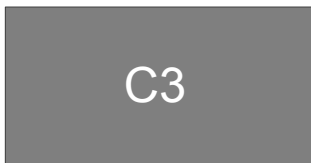

Ordering information

Order code	Package	Base qty	Delivery mode
RL0201Q1801LC	DFN0603	10k	Tape and reel

