

N76039D

100V N-Channel Power MOSFET

1. FEATURES

- Low thermal impedance.
- Fast switching.
- We declare that the material of product compliance with RoHS requirements and Halogen Free.

2. APPLICATIONS

- Power Tools
- UPS
- Motor Control

3. DEVICE MARKING AND RESISTOR VALUES

Device	Marking	Shipping
N76039D	LN76039	3000/Tape&Reel

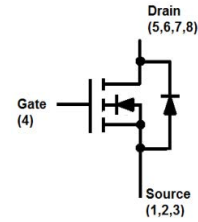
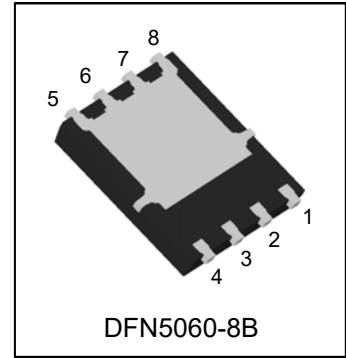

4. MAXIMUM RATINGS(Ta = 25°C)

Parameter		Symbol	Limits	Unit
Drain-to-Source Voltage		VDS	100	V
Gate-to-Source Voltage		VGS	±20	V
Continuous Drain Current(Note 1)	TA=25°C	ID	25	A
	TA=75°C		22	
	TC=25°C		123	
	TC=75°C		108	
Pulsed Drain Current (Note 2)		IDM	100	A
Avalanche Current		IAS	40	A
Avalanche Energy(L=0.1mH)		EAS	80	mJ
Power Dissipation(Note 1)	TA=25°C	PD	2.5	W
	TC=25°C		62.5	
Operating Junction and Storage Temperature Range		Tj/Tstg	-55~+150	°C

5. THERMAL CHARACTERISTICS

Parameter	Symbol	Max	Unit
Thermal Resistance,Junction-to-Ambient(Note 1)	RθJA	50	°C/W
Thermal Resistance,Junction-to-Ambient(Note 3)	RθJA	125	
Thermal Resistance,Junction-to-Case	RθJC	2	

- 1.Surface mounted on 1.5 x 1.5 FR4 board using 1 sq in pad, 2 oz Cu.
- 2.Pulse width limited by maximum junction temperature
- 3.Surface mounted on FR4 board using the minimum recommended pad size.



6. ELECTRICAL CHARACTERISTICS (Ta= 25°C)

Characteristic	Symbol	Min.	Typ.	Max.	Unit	
STATIC						
Drain–Source Breakdown Voltage (VGS = 0 V, ID = 250 μA)	VBRDSS	100	-	-	V	
Gate Threshold Voltage (VDS = VGS , ID = 250 μA)	VGS(th)	2	-	4	V	
Gate-Body leakage current (VDS = 0 V, VGS = ±20 V)	IGSS	-	-	±100	nA	
Zero Gate Voltage Drain Current (VDS = 80 V, VGS = 0 V)	IDSS	-	-	10	μA	
Drain-to-Source On-Resistance (Note 4) (VGS = 10 V, ID = 15 A)	RDS(on)	-	-	3.9	mΩ	
Diode Forward Voltage (IS = 2 A, VGS = 0 V)	VSD	-	-	1.2	V	
DYNAMIC						
Total Gate Charge	(VDS = 50 V, VGS = 10 V, ID = 15 A)	Qg	-	105	-	nC
Gate to Source Charge		Qgs	-	26	-	
Gate to Drain Charge		Qgd	-	41	-	
Turn-on Delay Time	(VDS= 50 V, VGEN=10 V, RG = 6 Ω, ID=10 A)	td(on)	-	36	-	nS
Rise Time		tr	-	48	-	
Turn-Off Delay Time		td(off)	-	154	-	
Fall Time		tf	-	134	-	
Input Capacitance	(VDS = 50 V, VGS = 0 V, f = 100kHz)	Ciss	-	6376	-	pF
Output Capacitance		Coss	-	784	-	
Reverse Transfer Capacitance		Crss	-	25	-	

4. Pulse test: PW ≤ 300μs duty cycle ≤ 2%.

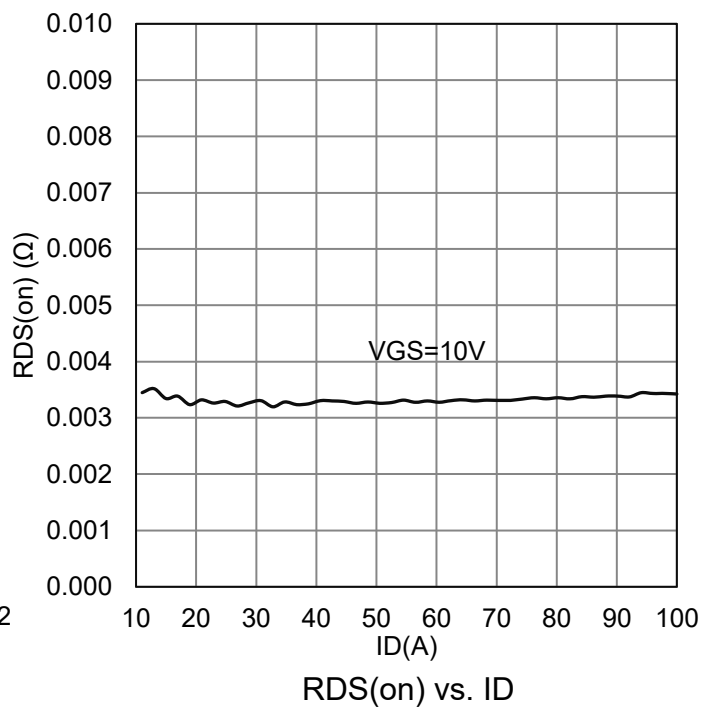
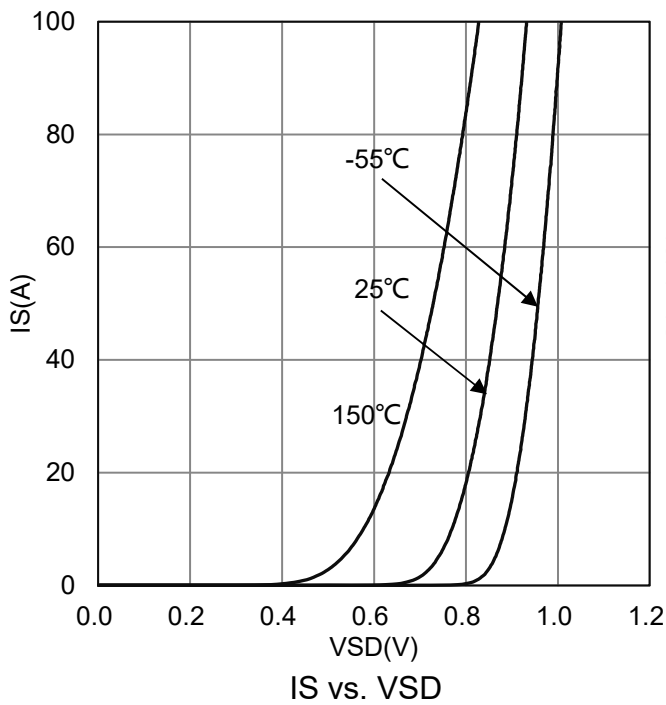
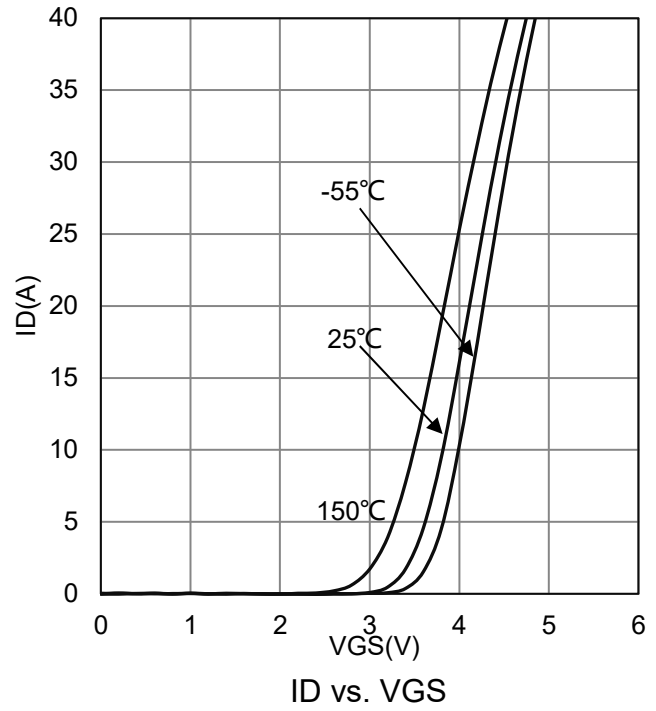
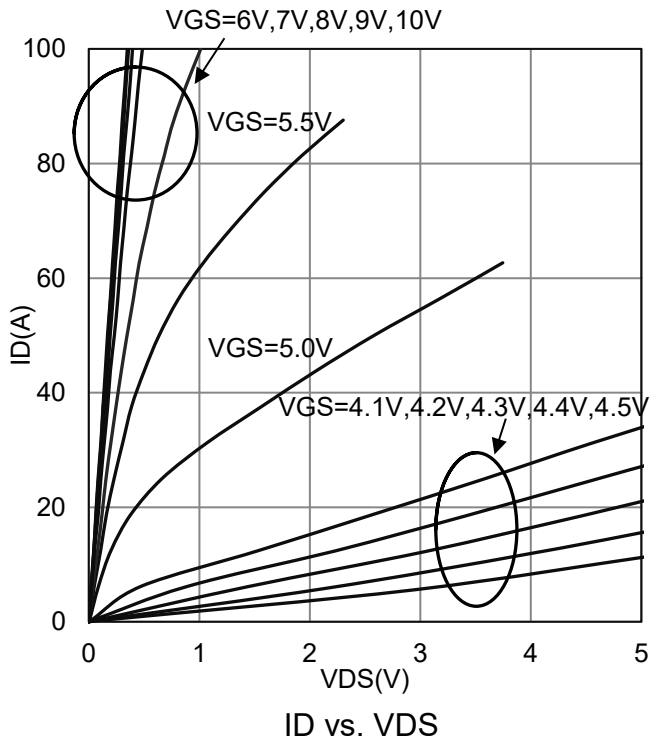

7. ELECTRICAL CHARACTERISTICS CURVES

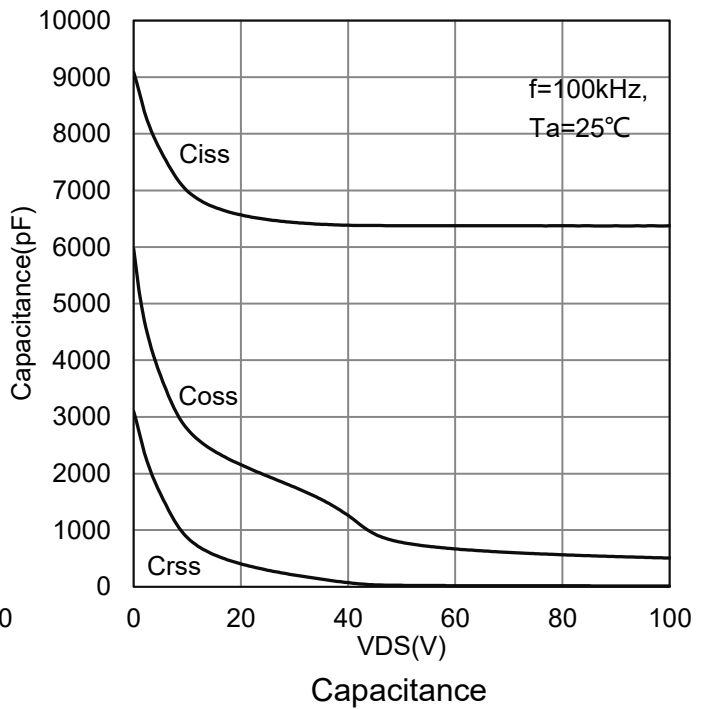
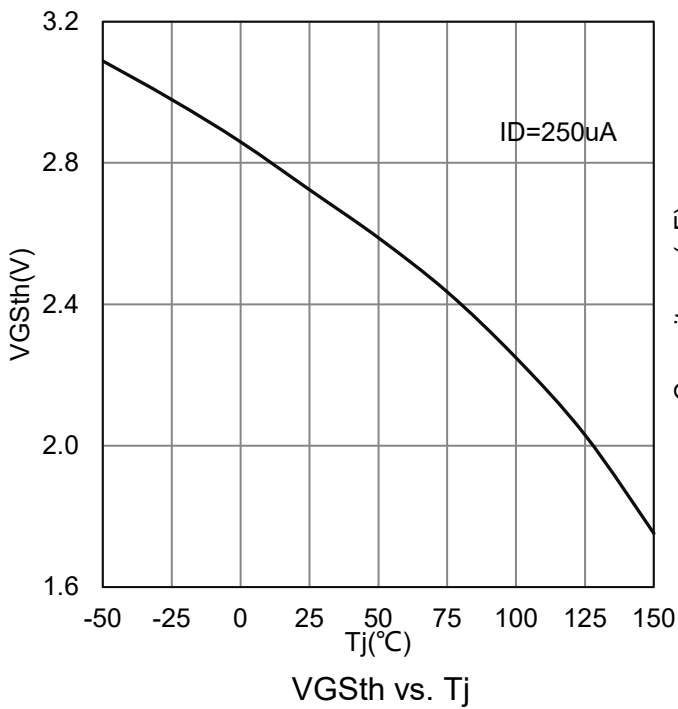
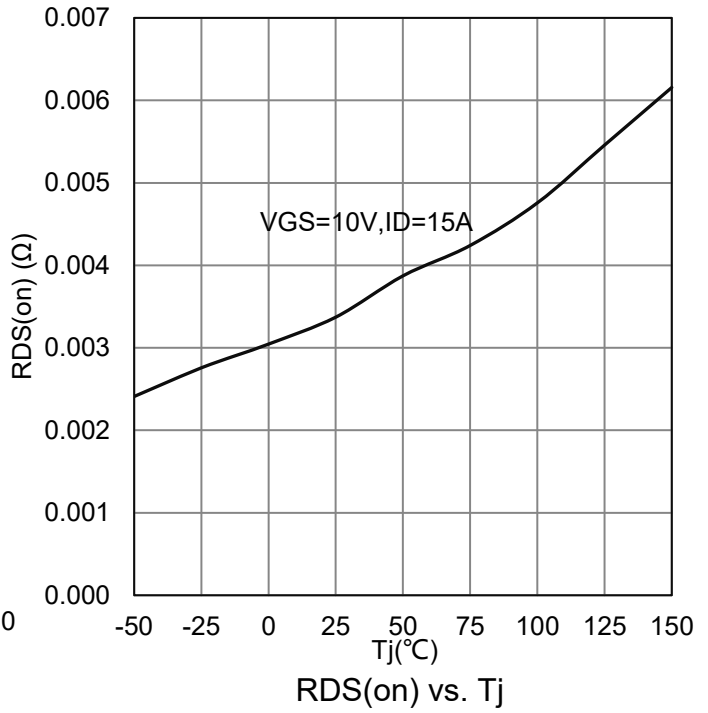
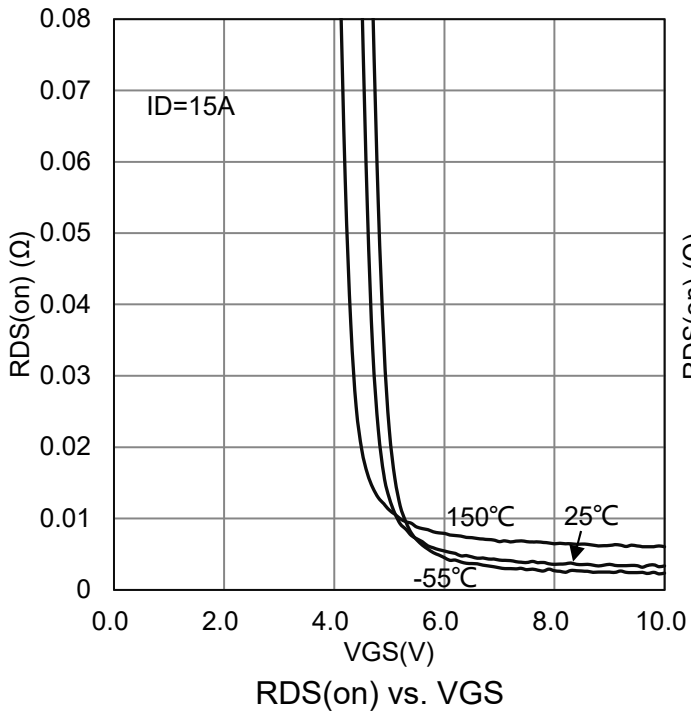
7. ELECTRICAL CHARACTERISTICS CURVES(Con.)

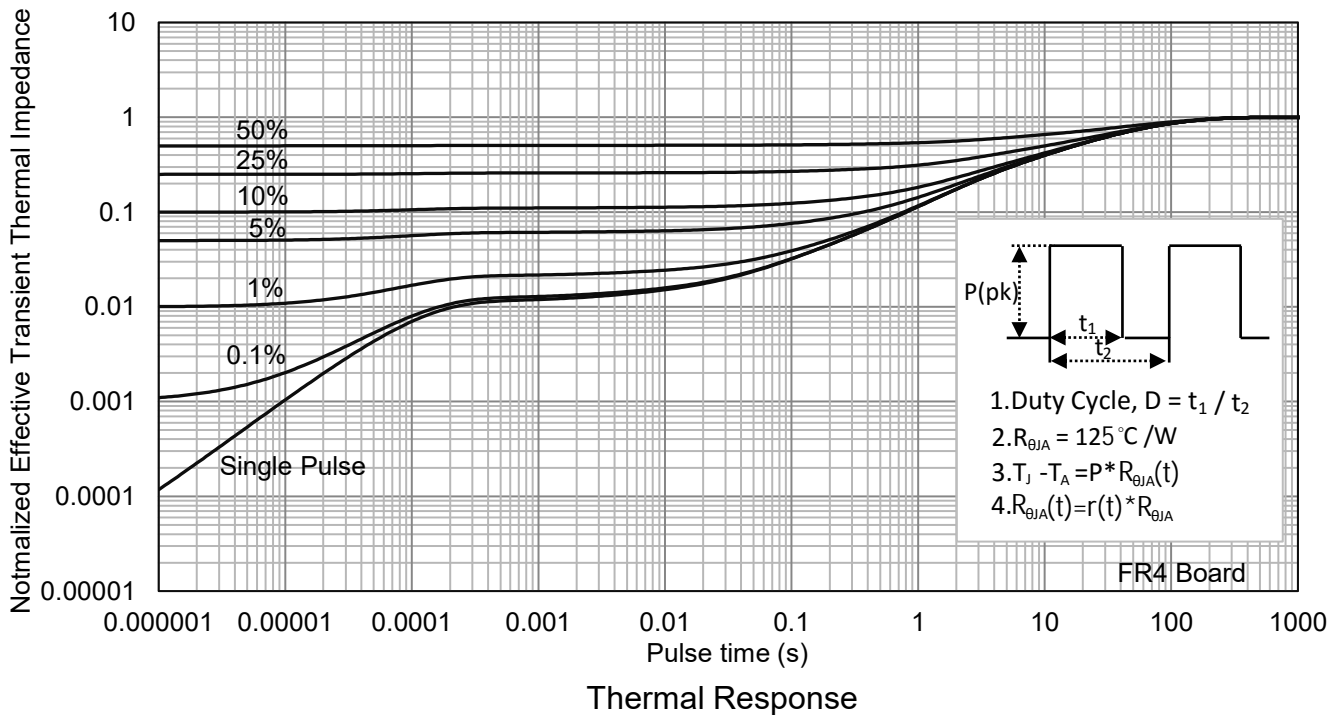
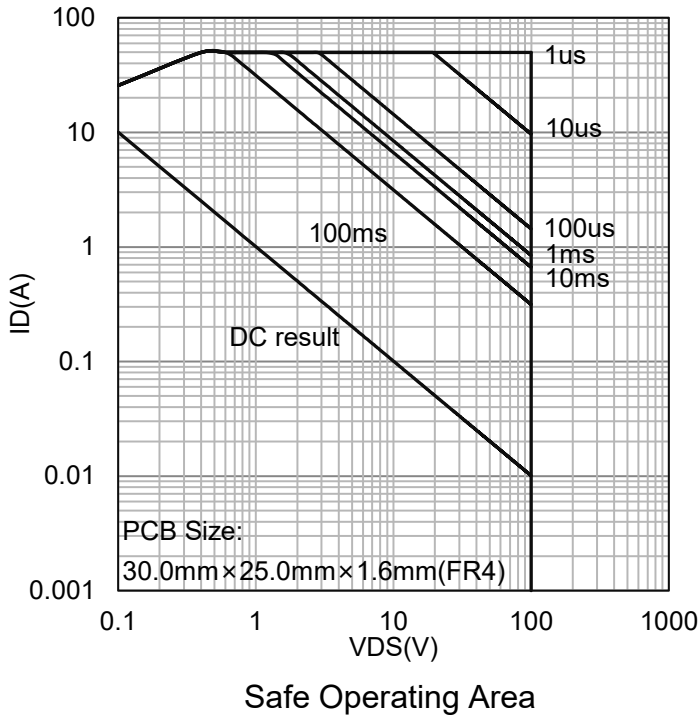
7. ELECTRICAL CHARACTERISTICS CURVES(Con.)

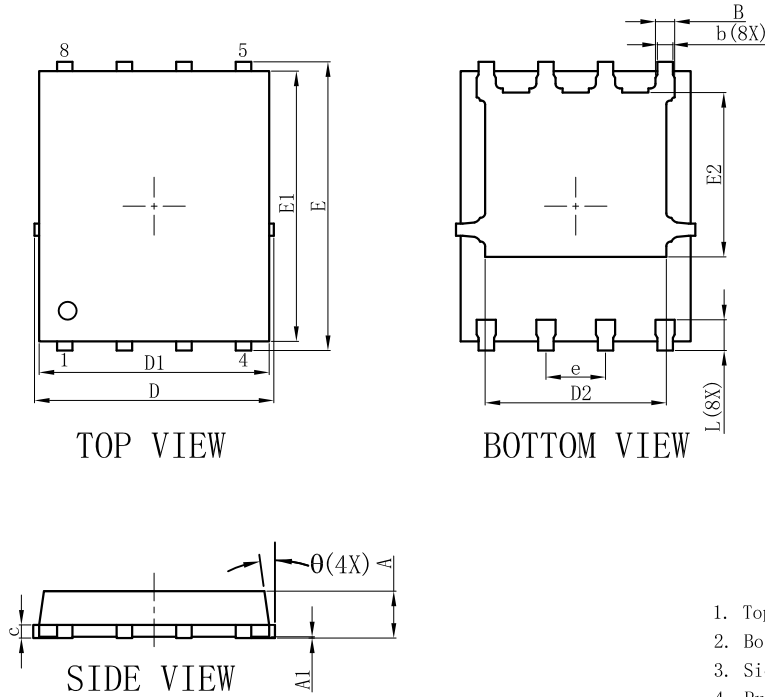
8. OUTLINE AND DIMENSIONS
DFN5060-8B

DFN5060-8B			
DIM	MIN	NOR	MAX
A	0.90	1.00	1.10
A1	0.00	0.02	0.05
E	6.00	6.15	6.30
E1	5.66	5.76	5.86
E2	3.40	3.50	3.60
D	4.95	5.10	5.25
D1	4.80	4.90	5.00
D2	3.76	3.86	3.96
b	0.30	0.35	0.40
B	0.36	0.41	0.46
L	0.56	0.66	0.76
e	1.27BSC		
c	0.254REF.		
θ	0°	-	12°
All Dimensions in mm			

GENERAL NOTES

1. Top package surface finish Ra0.4±0.2um
2. Bottom package surface finish Ra0.7±0.2um
3. Side package surface finish Ra0.4±0.2um
4. Protrusion or Gate Burrs shall not exceed 0.05mm per side.
5. Offcenter Max0.038mm; Mismatch Max 0.038mm.

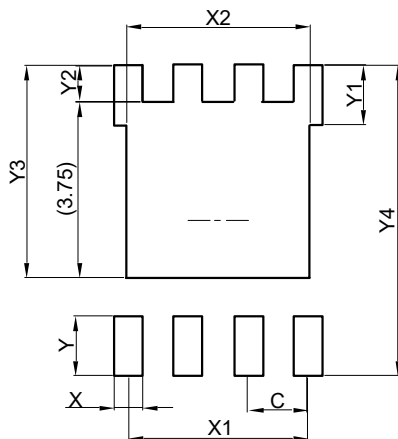
9. SOLDERING FOOTPRINT

DFN5060-8B	
DIM	(mm)
C	1.27
X	0.61
X1	3.81
X2	3.91
Y	1.27
Y1	1.27
Y2	0.77
Y3	4.52
Y4	6.61

