

N7404D

40V N-Channel Power MOSFET

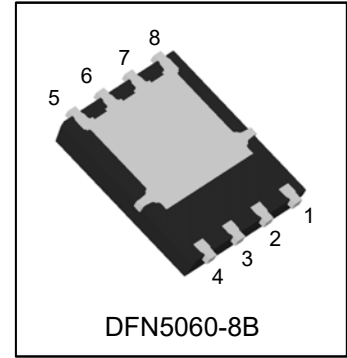

1. FEATURES

- Advanced trench cell design
- Low Thermal Resistance
- High speed switch
- We declare that the material of product compliance with RoHS requirements and Halogen Free.

2. APPLICATIONS

- Power Tools
- DC-DC Converter
- Motor Control

3. DEVICE MARKING AND RESISTOR VALUES

Device	Marking	Shipping
N7404D	LN7404	3000/Tape&Reel

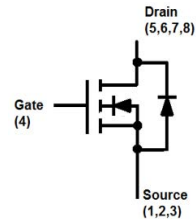

4. MAXIMUM RATINGS(Ta = 25°C)

Parameter		Symbol	Limits	Unit
Drain-to-Source Voltage		VDS	40	V
Gate-to-Source Voltage		VGS	±20	V
Continuous Drain Current(Note 1)	TA=25°C	ID	24	A
	TA=75°C		21	
	TC=25°C		109	
	TC=75°C		95	
Pulsed Drain Current (Note 2)		IDM	96	A
Avalanche Current		IAS	35	A
Avalanche Energy(L=0.1mH)		EAS	61.25	mJ
Power Dissipation(Note 1)	TA=25°C	PD	2.5	W
	TC=25°C		62.5	
Operating Junction and Storage Temperature Range		Tj/Tstg	-55~+150	°C

5. THERMAL CHARACTERISTICS

Parameter	Symbol	Max	Unit
Thermal Resistance,Junction-to-Ambient(Note 1)	RθJA	50	°C/W
Thermal Resistance,Junction-to-Ambient(Note 3)	RθJA	111	
Thermal Resistance,Junction-to-Case	RθJC	2	

- 1.Surface mounted on "1.5 x 1.5" FR4 board using 1 sq in pad, 2 oz Cu.
- 2.Pulse width limited by maximum junction temperature.
- 3.Surface mounted on FR4 board using the minimum recommended pad size.



6. ELECTRICAL CHARACTERISTICS (Ta= 25°C)

Characteristic	Symbol	Min.	Typ.	Max.	Unit	
Static						
Drain-Source Breakdown Voltage (VGS = 0V, ID = 250μA)	V(BR)DSS	40	-	-	V	
Gate Threshold Voltage (VDS = VGS, ID = 250μA)	VGS(th)	1	2	3	V	
Gate Leakage Current (VDS = 0 V, VGS = ±20V)	IGSS	-	-	±100	nA	
Zero Gate Voltage Drain Current (VDS = 32 V, VGS = 0 V)	IDSS	-	-	1	μA	
Drain-Source On-Resistance(Note 4) (VGS = 10 V, ID = 15 A) (VGS = 4.5 V, ID = 15 A)	RDS(on)	- -	2 3.2	3 4.3	mΩ	
Diode Forward Voltage(Note 4) (IS = 1 A, VGS = 0 V)	VSD	-	0.7	1.3	V	
Dynamic						
Total Gate Charge	(VDS = 20 V, VGS = 4.5 V, ID = 2 A)	Qg	-	23.6	-	nC
Gate-Source Charge		Qgs	-	5.5	-	
Gate-Drain Charge		Qgd	-	11.7	-	
Input Capacitance	(VDS = 15 V, VGS = 0 V, f = 1 MHz)	Ciss	-	2478	-	pF
Output Capacitance		Coss	-	1387	-	
Reverse Transfer Capacitance		Crss	-	146	-	
Turn-On Delay Time	(VDS = 20 V, RL = 1.3 Ω, ID = 2 A, VGEN = 10 V, RGEN = 6 Ω)	td(on)	-	13	-	ns
Rise Time		tr	-	18	-	
Turn-Off Delay Time		td(off)	-	68	-	
Fall Time		tf	-	37	-	

 4. Pulse test: $PW \leq 300\mu s$ duty cycle $\leq 2\%$.

7 ELECTRICAL CHARACTERISTICS CURVES

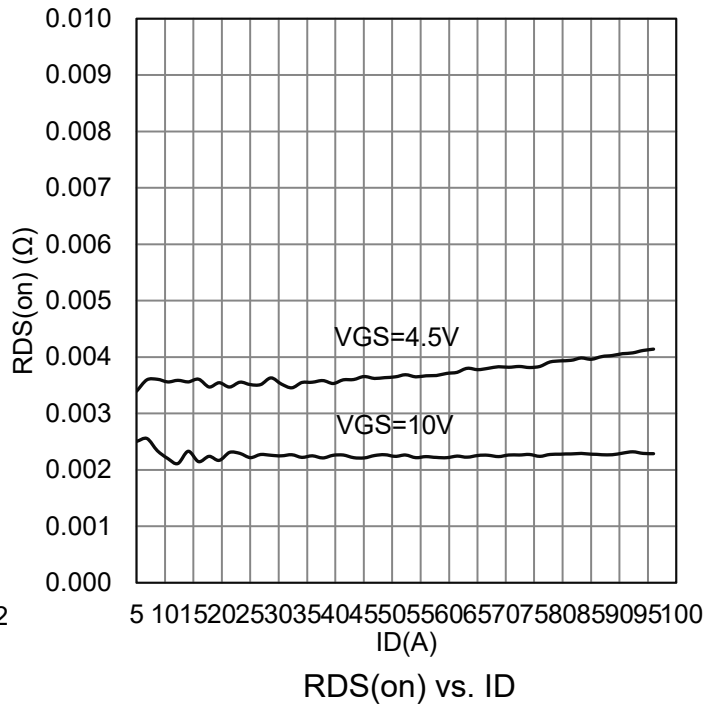
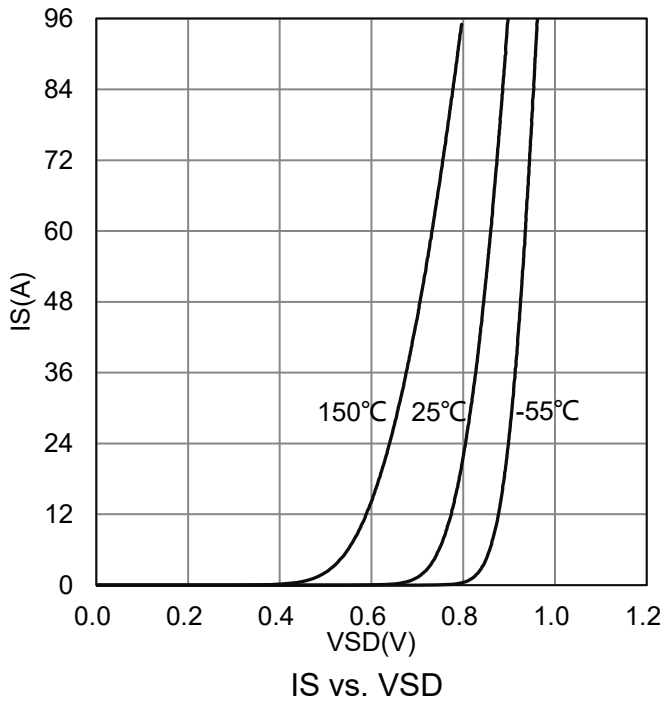
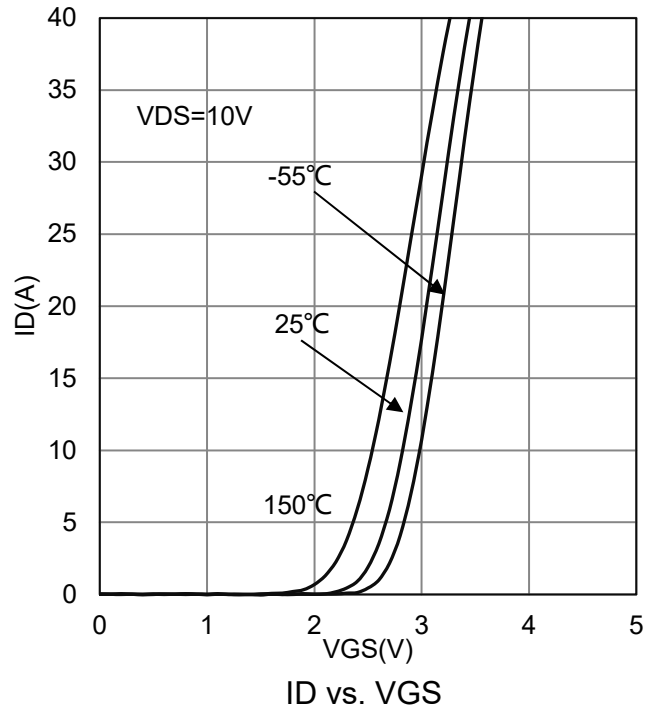
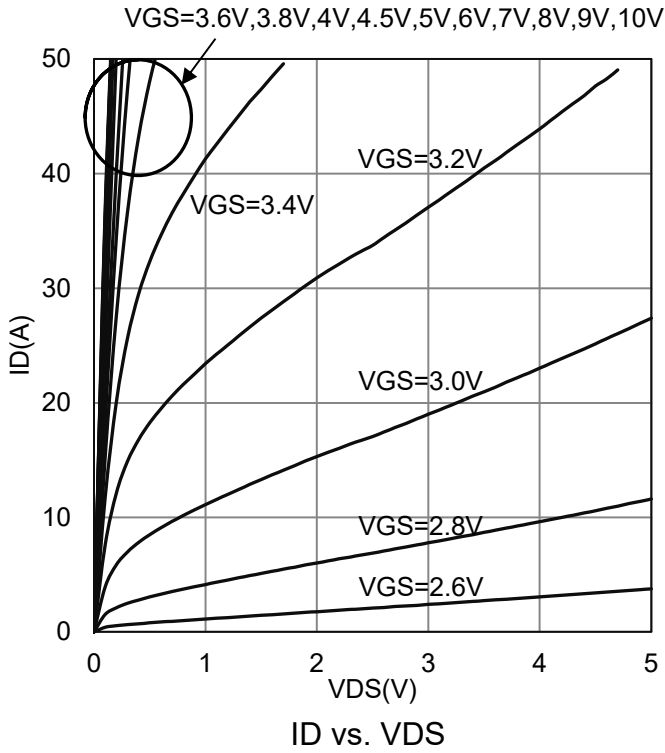

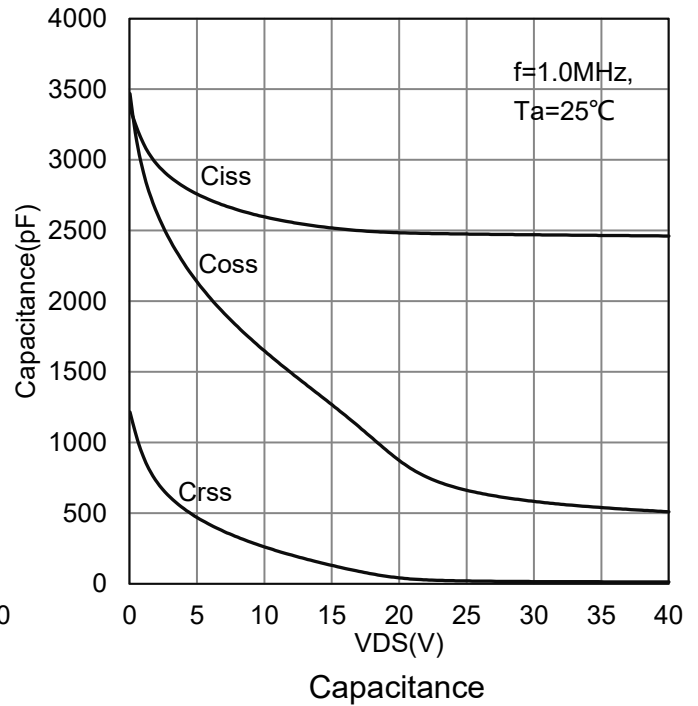
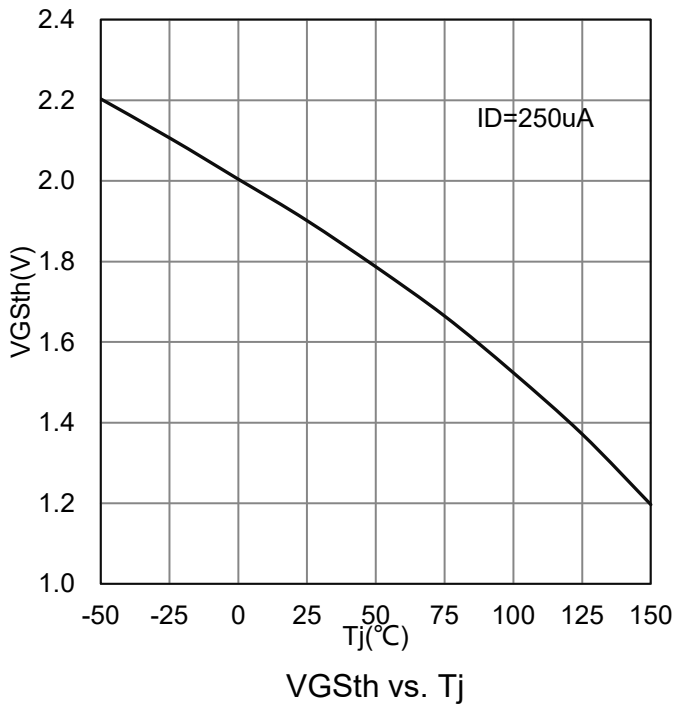
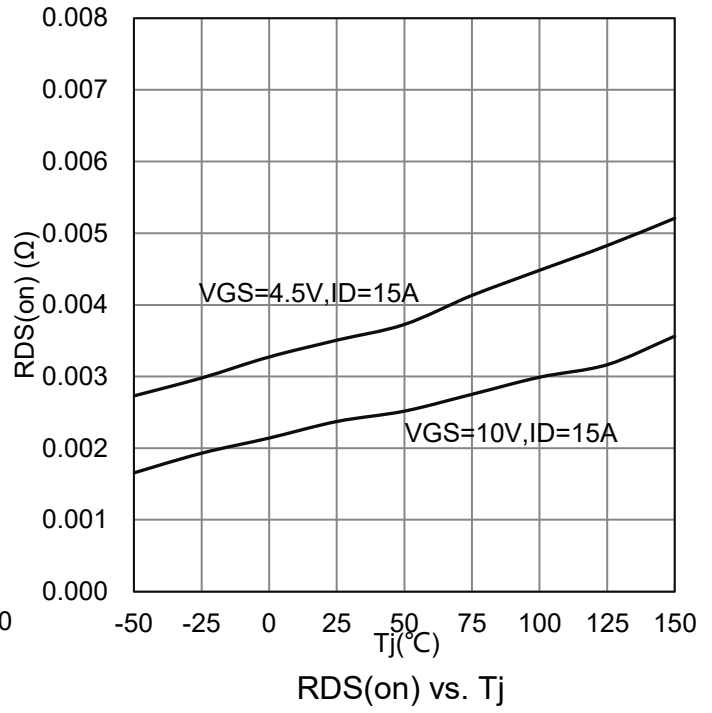
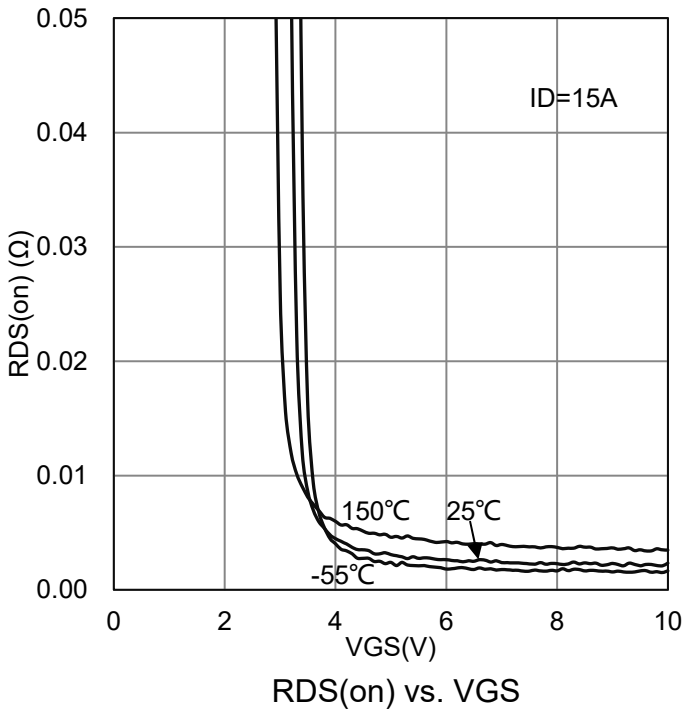
7. ELECTRICAL CHARACTERISTICS CURVES(Con.)

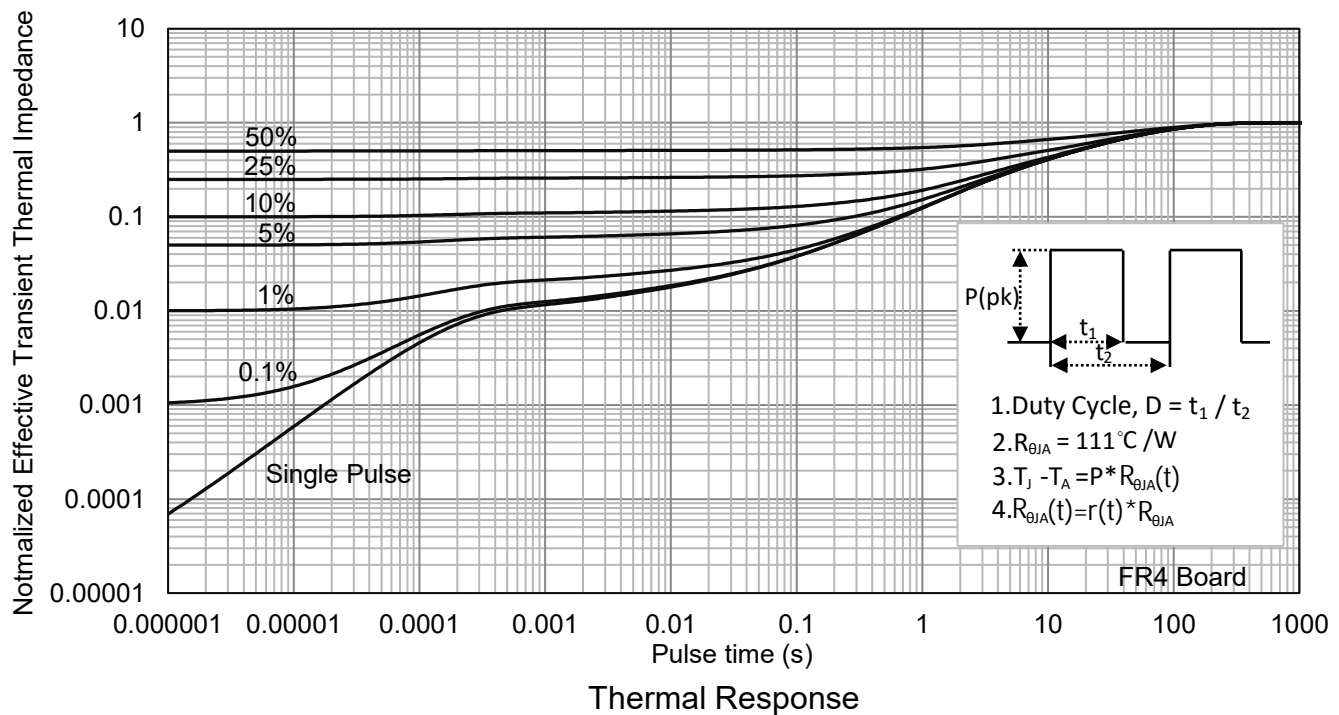
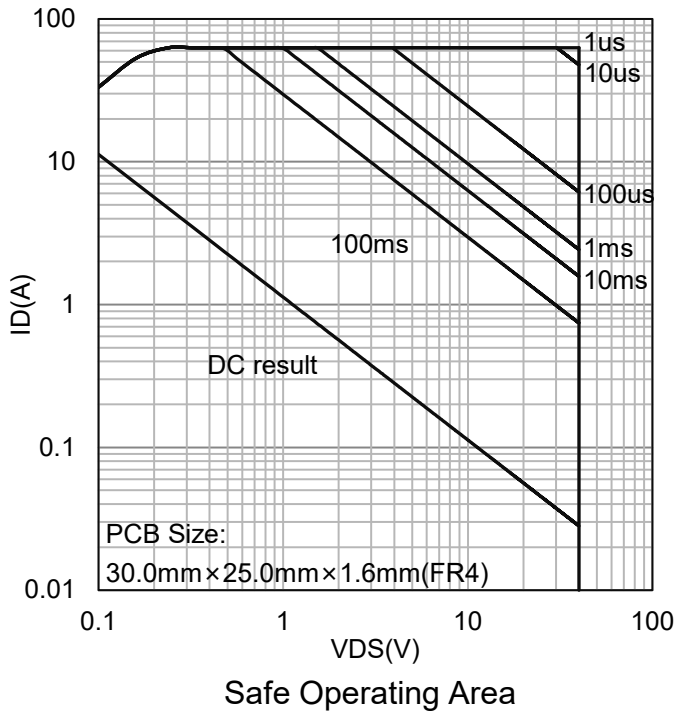
7. ELECTRICAL CHARACTERISTICS CURVES(Con.)

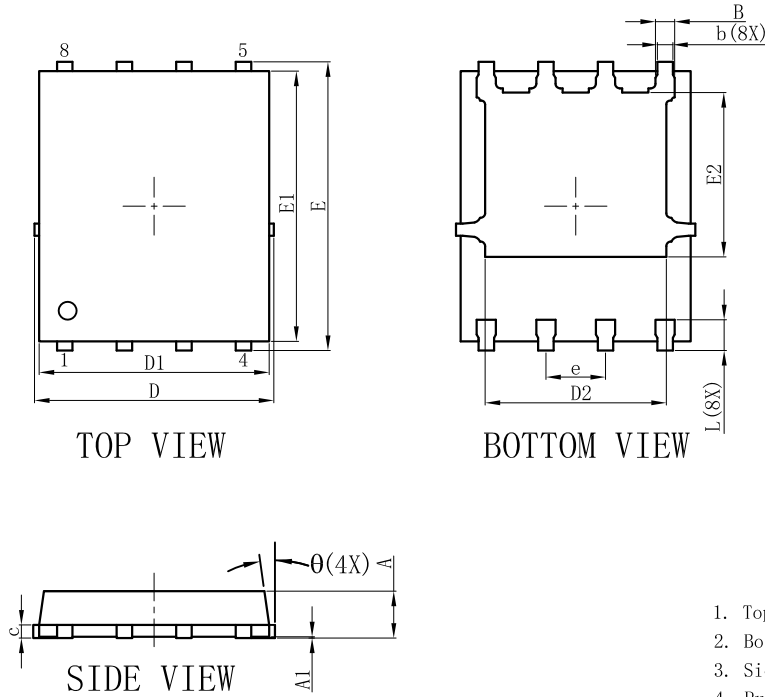
8. OUTLINE AND DIMENSIONS
DFN5060-8B

DFN5060-8B			
DIM	MIN	NOR	MAX
A	0.90	1.00	1.10
A1	0.00	0.02	0.05
E	6.00	6.15	6.30
E1	5.66	5.76	5.86
E2	3.40	3.50	3.60
D	4.95	5.10	5.25
D1	4.80	4.90	5.00
D2	3.76	3.86	3.96
b	0.30	0.35	0.40
B	0.36	0.41	0.46
L	0.56	0.66	0.76
e	1.27BSC		
c	0.254REF.		
θ	0°	-	12°
All Dimensions in mm			

GENERAL NOTES

1. Top package surface finish Ra0.4±0.2um
2. Bottom package surface finish Ra0.7±0.2um
3. Side package surface finish Ra0.4±0.2um
4. Protrusion or Gate Burrs shall not exceed 0.05mm per side.
5. Offcenter Max0.038mm; Mismatch Max 0.038mm.

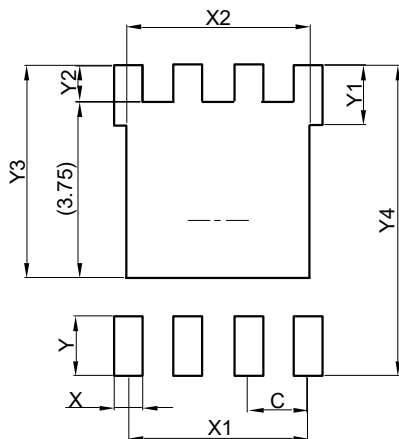
9. SOLDERING FOOTPRINT

DFN5060-8B	
DIM	(mm)
C	1.27
X	0.61
X1	3.81
X2	3.91
Y	1.27
Y1	1.27
Y2	0.77
Y3	4.52
Y4	6.61

