

BSS138W

S-BSS138W

Power MOSFET

200 mAmps, 50V N-Channel SOT-323

1. FEATURES

- We declare that the material of product compliance with RoHS requirements and Halogen Free.
- S- prefix for automotive and other applications requiring unique site and control change requirements; AEC-Q101 qualified and PPAP capable.
- Low threshold voltage ($V_{GS(th)}$: 0.5V...1.5V) makes it ideal for low voltage applications.

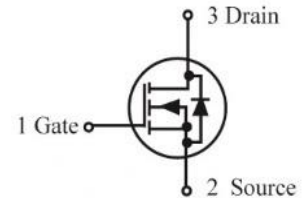
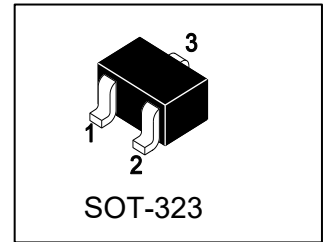

2. DEVICE MARKING AND ORDERING INFORMATION

Device	Marking	Shipping
BSS138W	J1	3000/Tape&Reel

3. MAXIMUM RATINGS($T_a = 25^\circ\text{C}$)

Parameter	Symbol	Limits	Unit
Drain-Source Voltage	VDSS	50	V
Gate-to-Source Voltage – Continuous	VGS	± 20	V
Drain Current			mA
– Continuous $T_A = 25^\circ\text{C}$	ID	200	
– Pulsed ($t_p \leq 10\mu\text{s}$)	IDM	800	

4. THERMAL CHARACTERISTICS

Parameter	Symbol	Limits	Unit
Total Device Dissipation, FR-5 Board (Note 1) @ $T_A = 25^\circ\text{C}$ Derate above 25°C	PD	150	mW
		1.8	mW/ $^\circ\text{C}$
Thermal Resistance, Junction-to-Ambient(Note 1)	$R_{\theta JA}$	556	$^\circ\text{C}/\text{W}$
Junction and Storage temperature	T_J, T_{stg}	$-55 \sim +150$	$^\circ\text{C}$
Maximum Lead Temperature for Soldering Purposes, for 10 seconds	TL	260	$^\circ\text{C}$

1. FR-5 = 1.0×0.75×0.062 in.



5. ELECTRICAL CHARACTERISTICS (Ta= 25°C)

OFF CHARACTERISTICS

Characteristic	Symbol	Min.	Typ.	Max.	Unit
Drain–Source Breakdown Voltage (VGS = 0, ID = 250μA)	VBRDSS	50	-	-	V
Zero Gate Voltage Drain Current (VGS = 0, VDS = 25 V) (VGS = 0, VDS = 50 V)	IDSS	- -	- -	0.1 0.5	μA
Gate–Body Leakage Current, Forward (VGS = 20 V)	IGSSF	-	-	0.1	μA
Gate–Body Leakage Current, Reverse (VGS = - 20 V)	IGSSR	-	-	-0.1	μA

ON CHARACTERISTICS (Note 2)

Gate Threshold Voltage (VDS = VGS, ID = 1.0mA)	VGS(th)	0.5	-	1.5	V
Static Drain–Source On–State Resistance (VGS = 2.75 V, ID < 200 mA, TA = -40°C to +85°C) (VGS = 5.0 V, ID = 200 mA)	RDS(on)	- -	5.6 -	10 3.5	Ohms
Forward Transconductance (VDS = 25 V, ID = 200 mA, f = 1.0 kHz)	gfs	100	-	-	mS

DYNAMIC CHARACTERISTICS

Input Capacitance (VDS = 25 V, VGS = 0, f = 1.0 MHz)	Ciss	-	40	50	pF
Output Capacitance (VDS = 25 V, VGS = 0, f = 1.0 MHz)	Coss	-	12	25	pF
Reverse Transfer Capacitance (VDS = 25 V, VGS = 0, f = 1.0 MHz)	Crss	-	3.5	5.0	pF

SWITCHING CHARACTERISTICS

Turn-On Delay Time	(VDD = 30 V, ID =200 mA)	td(on)	-	-	20	ns
Turn-Off Delay Time		td(off)	-	-	20	

2.Pulse Test: Pulse Width $\leq 300 \mu s$, Duty Cycle $\leq 2.0\%$.



6. ELECTRICAL CHARACTERISTICS CURVES

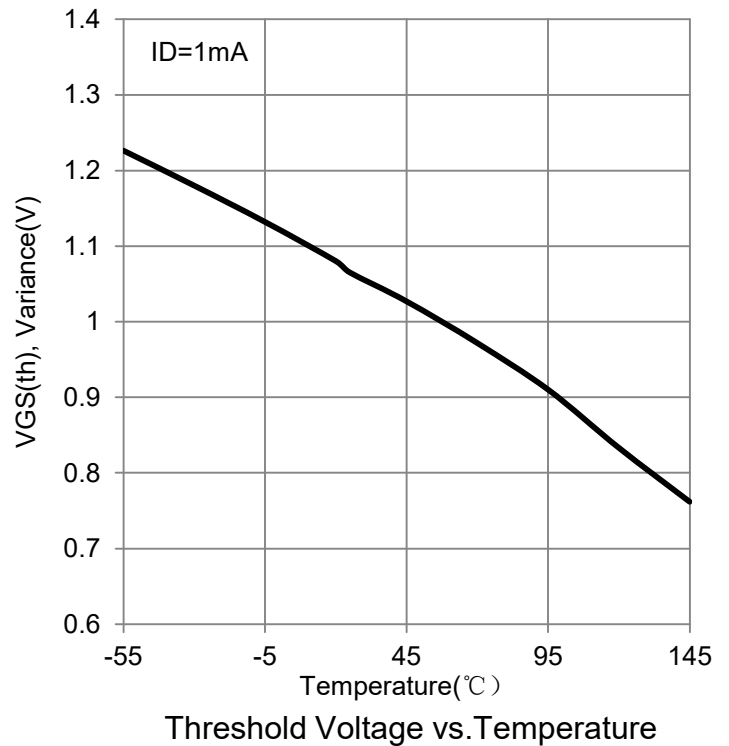
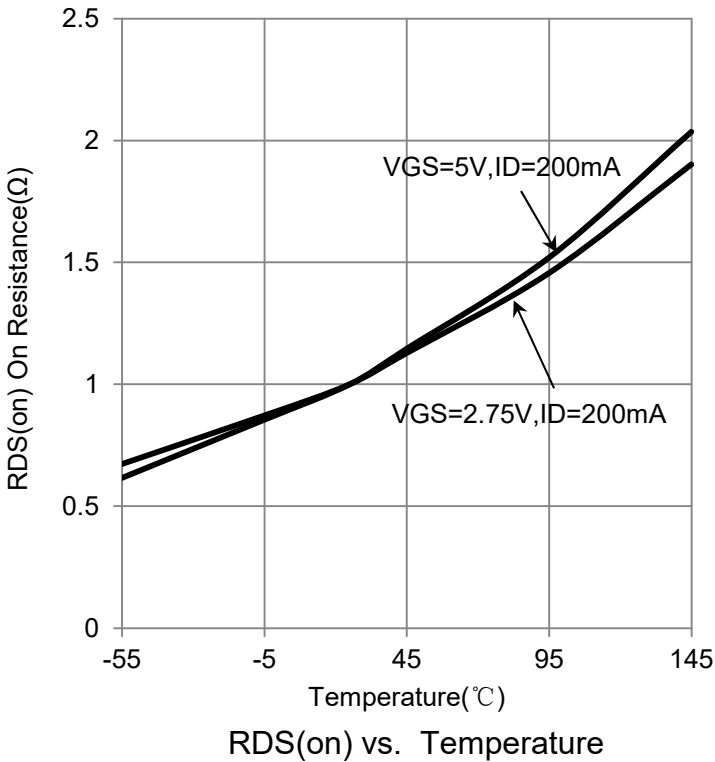
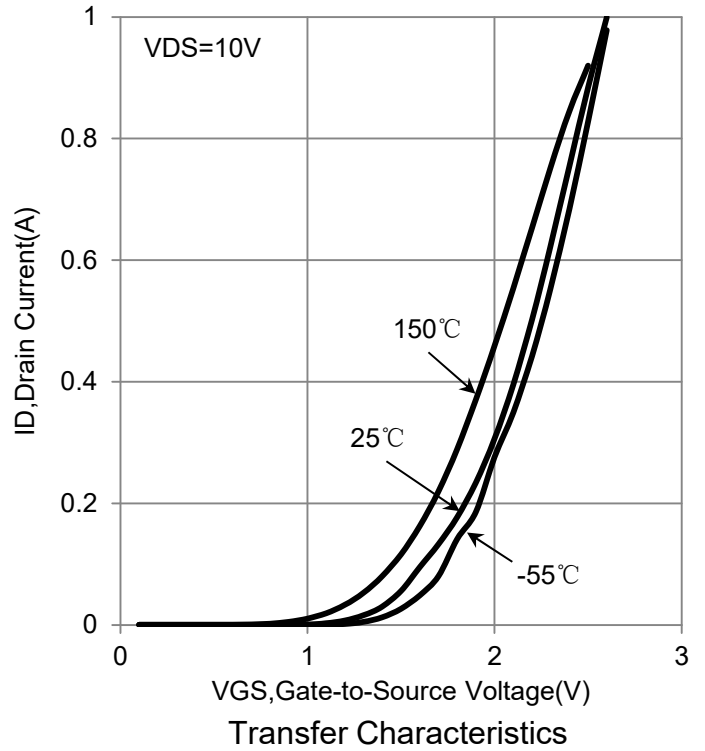
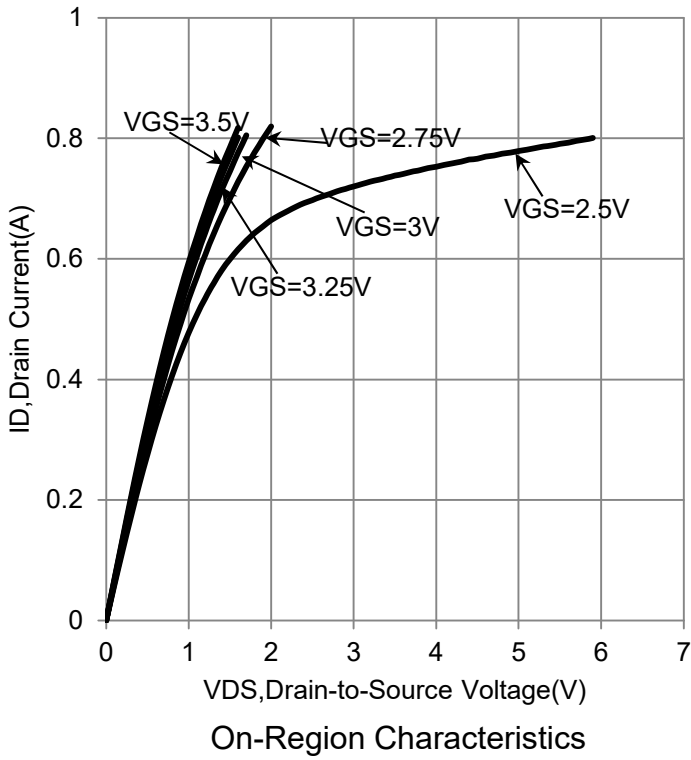

6.ELECTRICAL CHARACTERISTICS CURVES(Con.)

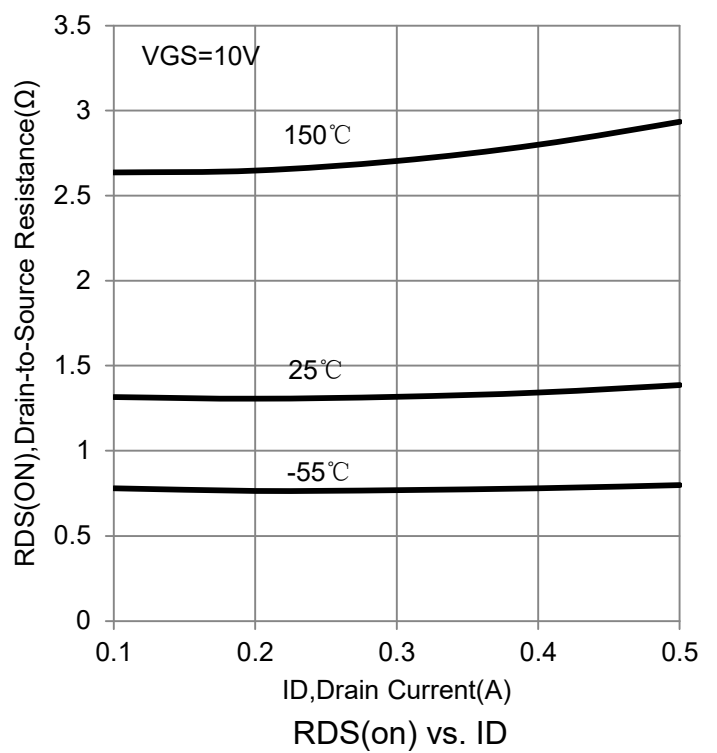
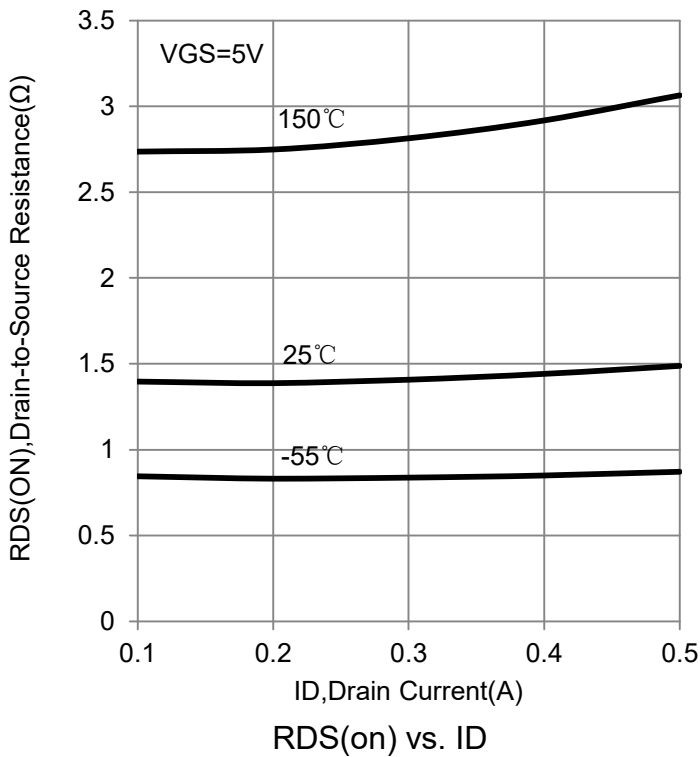
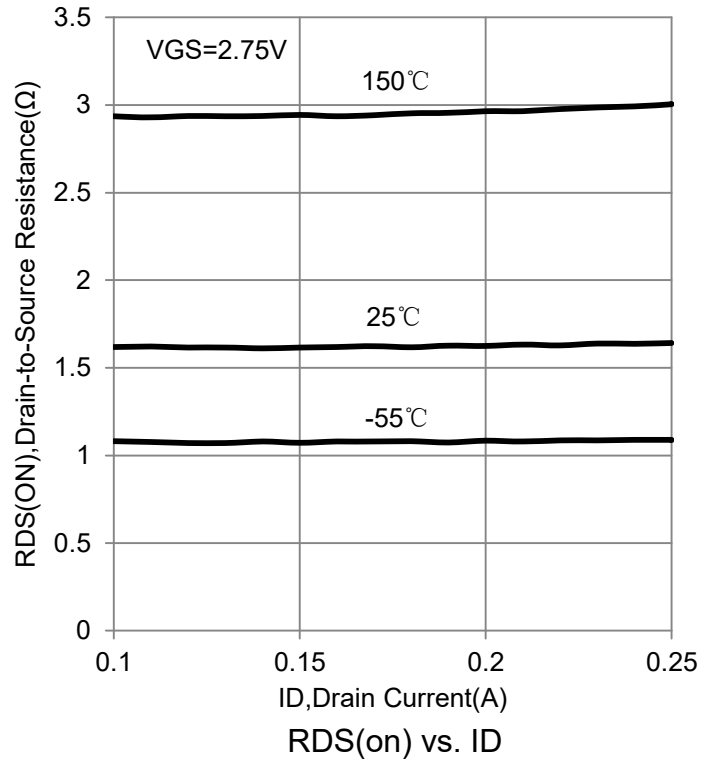
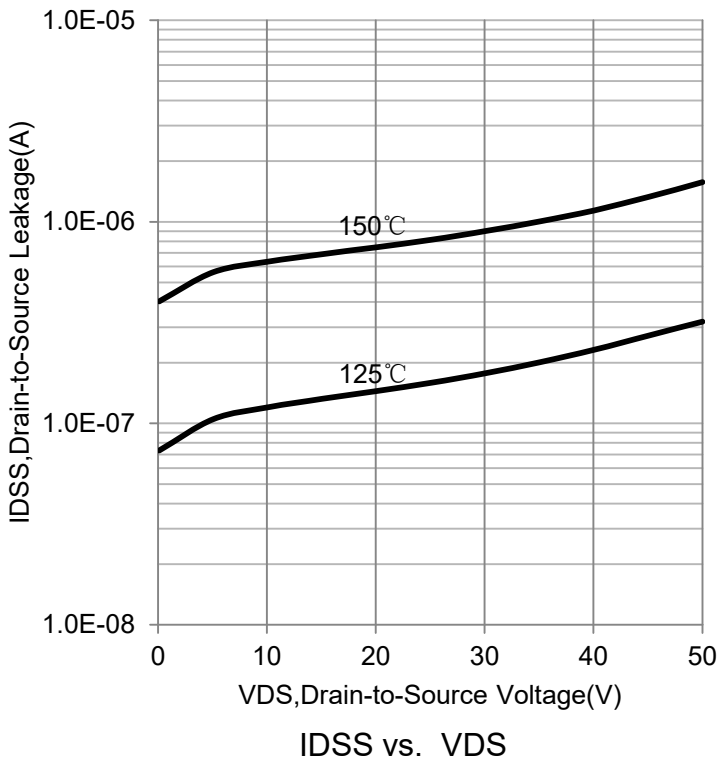

6.ELECTRICAL CHARACTERISTICS CURVES(Con.)

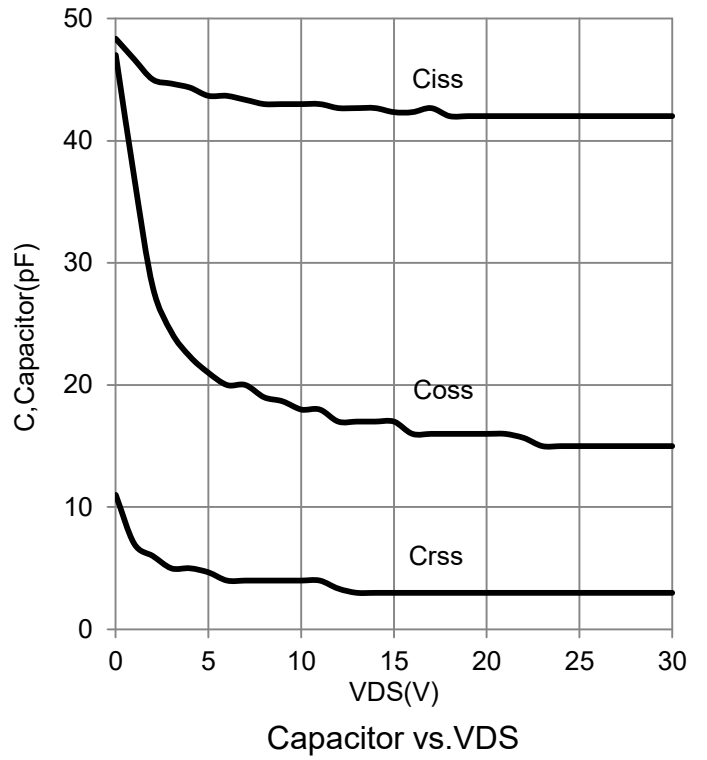
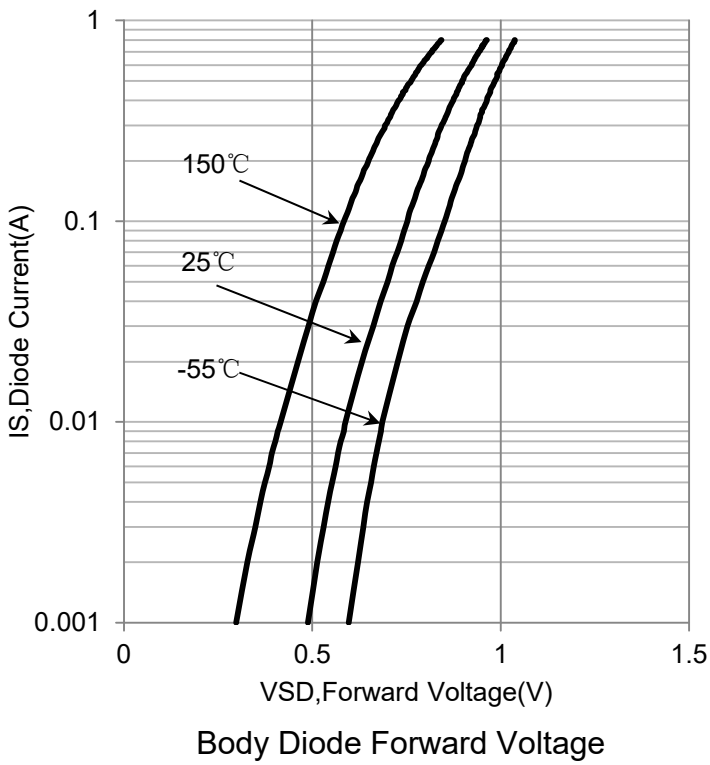

7.OUTLINE AND DIMENSIONS

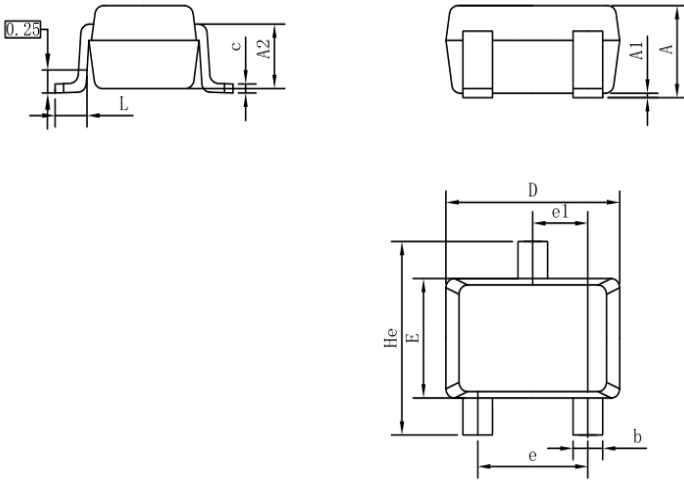

SOT-323			
DIM	MIN	NOR	MAX
A	0.80	0.95	1.00
A1	0.00	0.05	0.10
A2	0.7 REF		
b	0.30	0.35	0.40
c	0.10	0.15	0.25
D	1.80	2.05	2.20
E	1.15	1.30	1.35
e	1.20	1.30	1.40
e1	0.65 BSC		
L	0.20	0.35	0.56
He	2.00	2.10	2.40
ALL Dimension in mm			

8.SOLDERING FOOTPRINT

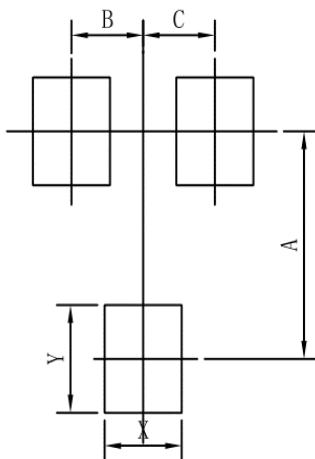

SOT23-6L	
DIM	MIN
A	1.90
B	0.65
C	0.65
X	0.70
Y	0.90

