

2N7002W

S-2N7002W

Small Signal MOSFET

115 mA, 60V N-Channel SOT-323

1. FEATURES

- We declare that the material of product compliance with RoHS requirements and Halogen Free.
- S- prefix for automotive and other applications requiring unique site and control change requirements; AEC-Q101 qualified and PPAP capable.
- ESD Protected:1000V

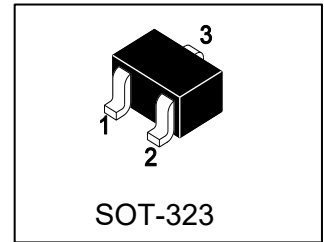

2. DEVICE MARKING AND ORDERING INFORMATION

Device	Marking	Shipping
2N7002W	6C	3000/Tape&Reel

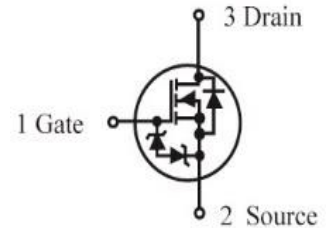

3. MAXIMUM RATINGS(Ta = 25°C)

Parameter	Symbol	Limits	Unit
Drain-Source Voltage	VDSS	60	V
Drain-Gate Voltage (RGS = 1.0 MΩ)	VDGR	60	V
Drain Current	ID		mA
- Continuous TC = 25°C		±115	
TC = 100°C		±75	
- Pulsed (Note 1)	IDM	±800	
Gate-Source Voltage			
- Continuous	VGS	±20	V
- Non-repetitive (tp ≤ 50μs)	VGSM	±40	V

4. THERMAL CHARACTERISTICS

Parameter	Symbol	Limits	Unit
Total Device Dissipation, FR-5 Board (Note 2) @ TA = 25°C Derate above 25°C	PD	225	mW
		1.8	mW/°C
Thermal Resistance, Junction-to-Ambient(Note 2)	ROJA	556	°C/W
Junction and Storage temperature	TJ,Tstg	-55~+150	°C

1. Pulse Test: Pulse Width ≤ 300 μs, Duty Cycle ≤ 2.0%.
2. FR-5 = 1.0×0.75×0.062 in.



5. ELECTRICAL CHARACTERISTICS (Ta= 25°C)

OFF CHARACTERISTICS

Characteristic	Symbol	Min.	Typ.	Max.	Unit
Drain–Source Breakdown Voltage (VGS = 0, ID = 10μA)	VBRDSS	60	-	-	V
Zero Gate Voltage Drain Current TJ = 25°C (VGS = 0, VDS = 60 V) TJ = 125°C	IDSS	-	-	1.0	μA
		-	-	500	
Gate–Body Leakage Current, Forward (VGS = 20 V)	IGSSF	-	-	1.0	μA
Gate–Body Leakage Current, Reverse (VGS = - 20 V)	IGSSR	-	-	-1.0	μA

ON CHARACTERISTICS (Note 3)

Gate Threshold Voltage (VDS = VGS, ID = 250μA)	VGS(th)	1.0	1.6	2.5	V
On–State Drain Current (VDS ≥ 2.0 VDS(on), VGS = 10 V)	ID(on)	500	-	-	mA
Static Drain–Source On–State Voltage (VGS = 10 V, ID = 500 mA) (VGS = 5.0 V, ID = 50 mA)	VDS(on)	-	-	3.75	V
		-	-	0.375	
Static Drain–Source On–State Resistance (VGS = 10 V, ID = 500 mA) TC = 25°C TC = 125°C (VGS = 5.0 V, ID = 50 mA) TC = 25°C TC = 125°C	RDS(on)	-	-	7.5	Ohms
		-	-	13.5	
		-	-	7.5	
		-	-	13.5	
Forward Transconductance (VDS ≥ 2.0 VDS(on), ID = 200 mA)	gfs	80	-	-	mmhos

DYNAMIC CHARACTERISTICS

Input Capacitance (VDS = 25 V, VGS = 0, f = 1.0 MHz)	Ciss	-	17	50	pF
Output Capacitance (VDS = 25 V, VGS = 0, f = 1.0 MHz)	Coss	-	10	25	pF
Reverse Transfer Capacitance (VDS = 25 V, VGS = 0, f = 1.0 MHz)	Crss	-	2.5	5.0	pF

SWITCHING CHARACTERISTICS

Turn-On Delay Time	(VDD = 25 V, ID = 500 mA, RG = 25Ω, RL = 50 Ω, Vgen = 10 V)	td(on)	-	7	20	ns
Turn-Off Delay Time		td(off)	-	11	40	

BODY–DRAIN DIODE RATINGS

Diode Forward On–Voltage (IS = 115 mA, VGS = 0 V)	VSD	-	-	1.5	V
Source Current Continuous (Body Diode)	IS	-	-	115	mA
Source Current Pulsed	ISM	-	-	800	mA

3.Pulse Test: Pulse Width ≤ 300 μs, Duty Cycle ≤ 2.0%.



6. ELECTRICAL CHARACTERISTICS CURVES

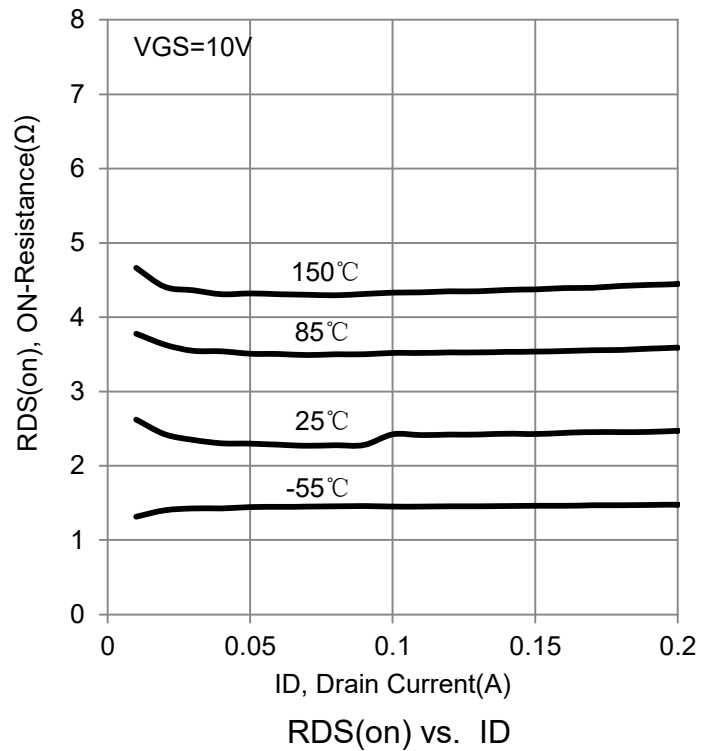
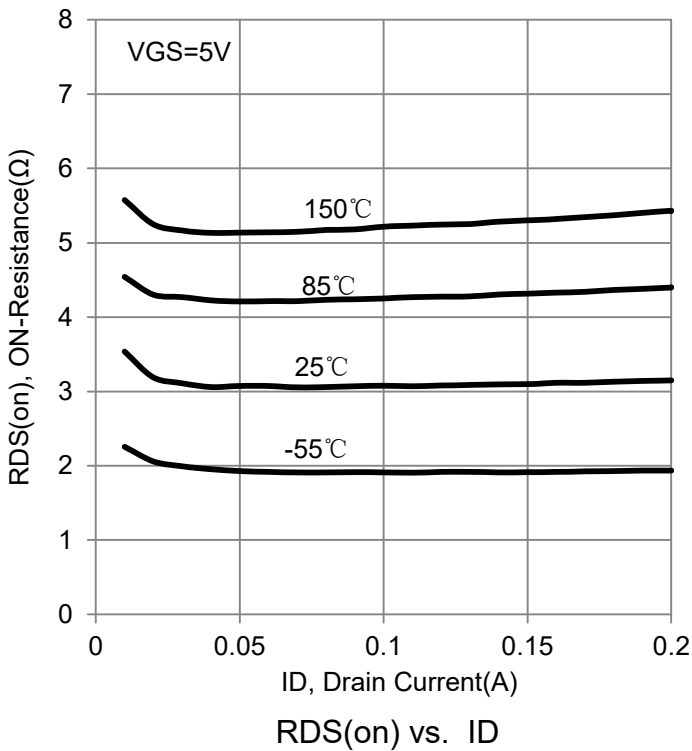
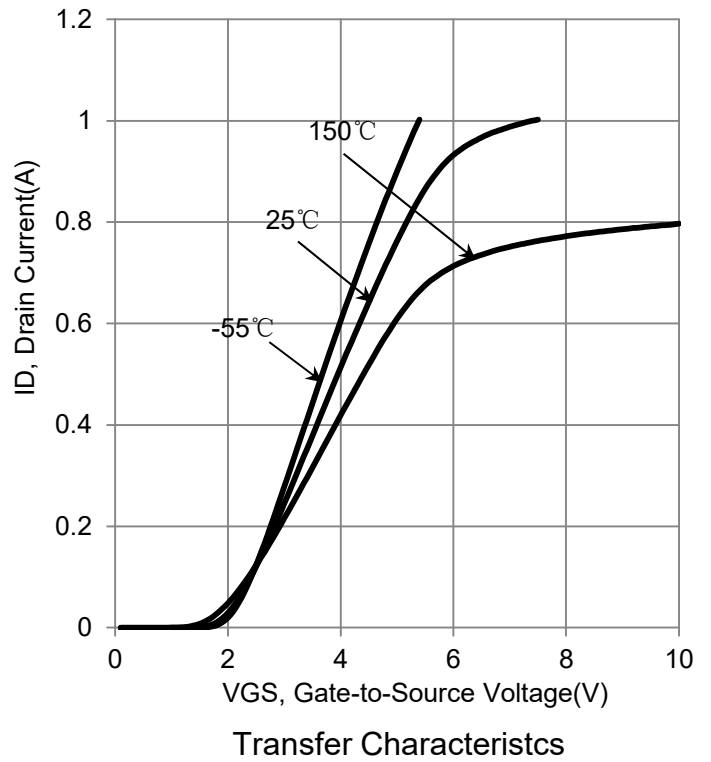
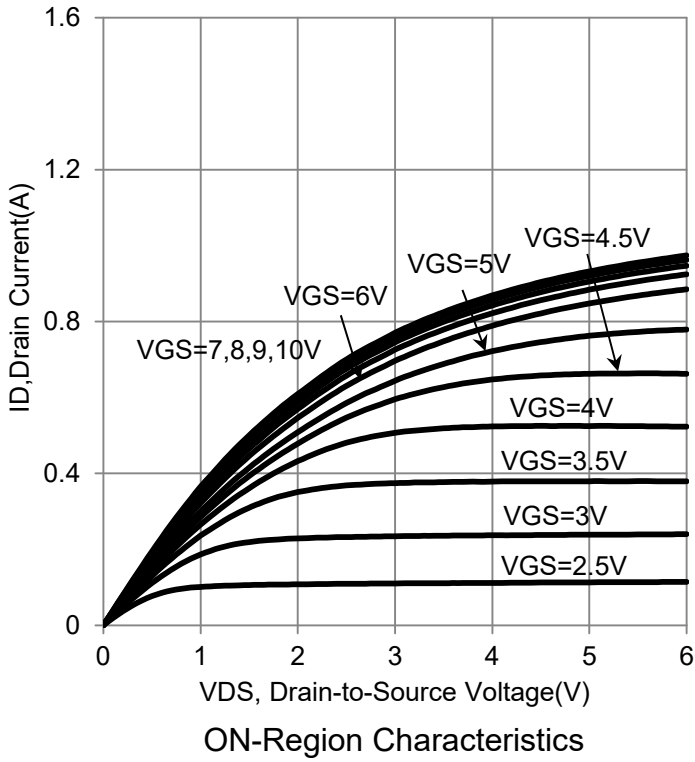

6. ELECTRICAL CHARACTERISTICS CURVES (Con.)

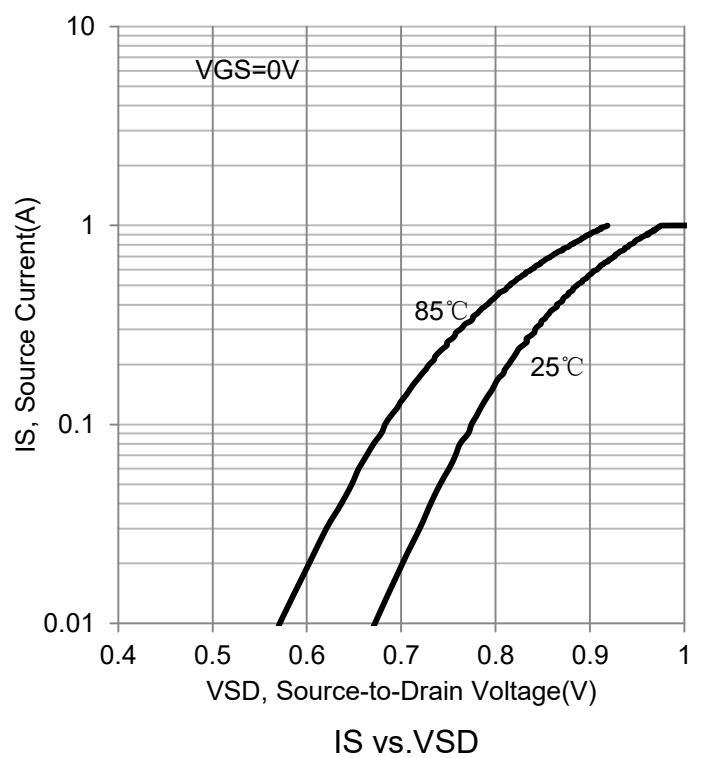
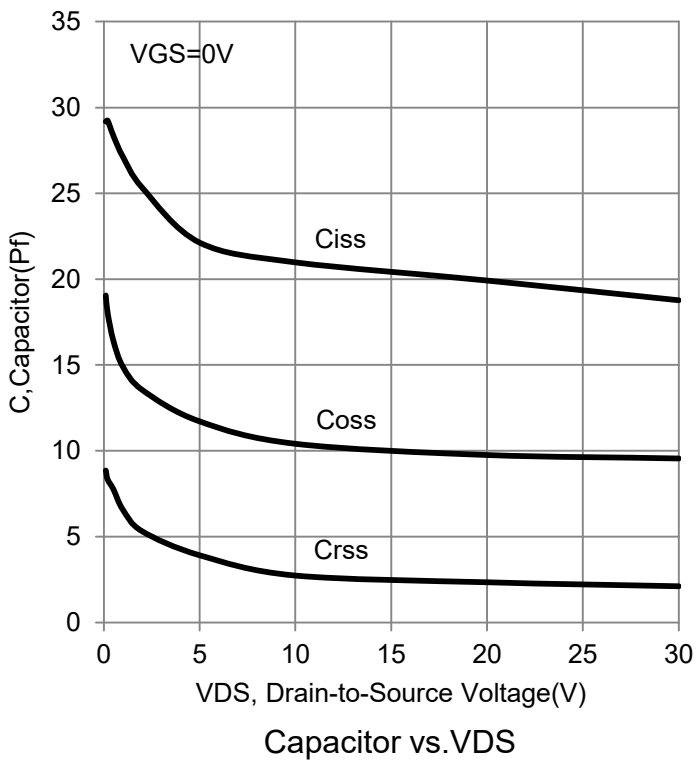
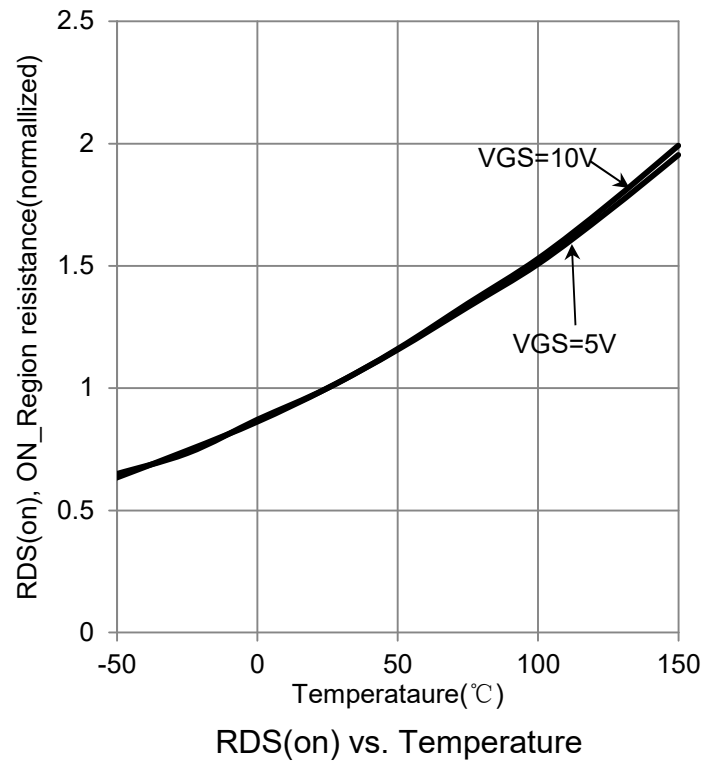
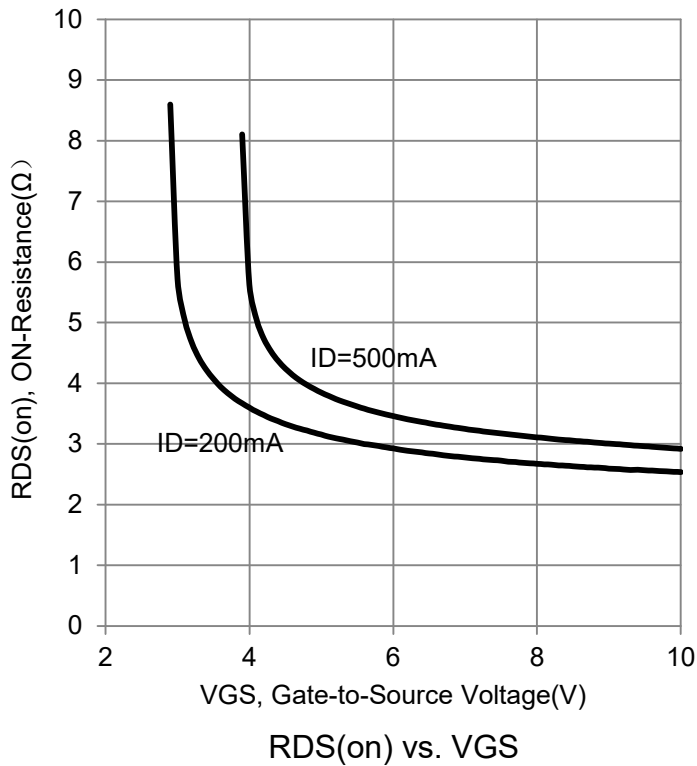

6. ELECTRICAL CHARACTERISTICS CURVES (Con.)

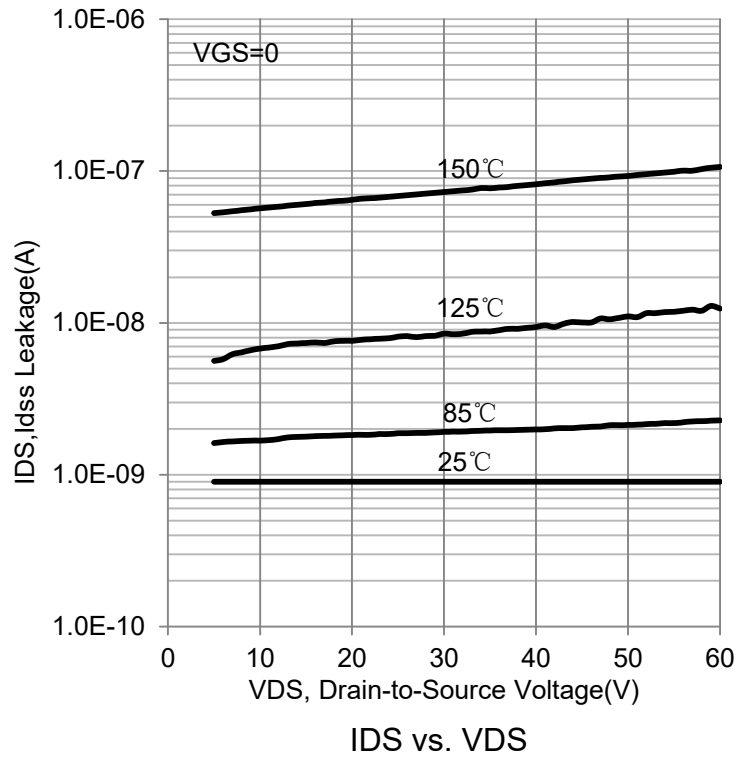
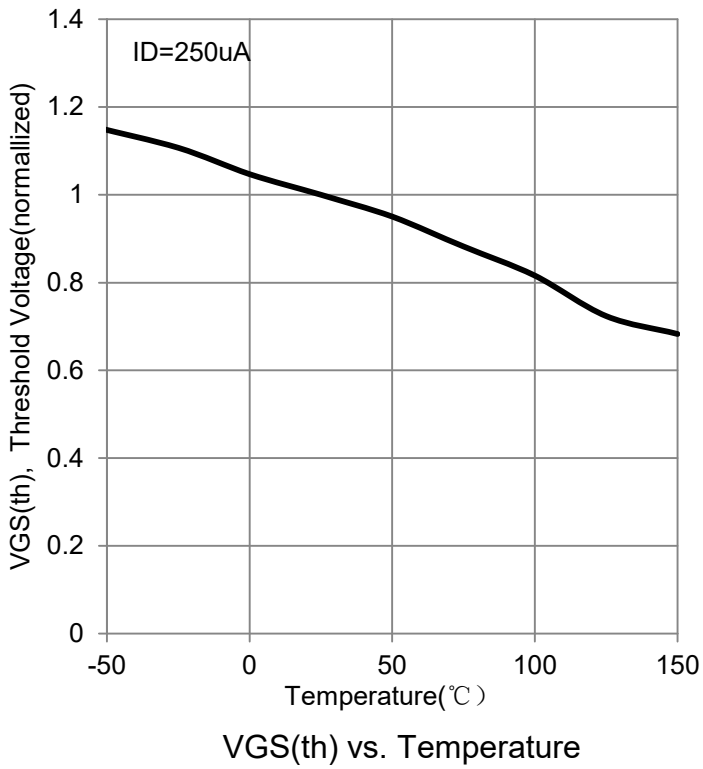

7.OUTLINE AND DIMENSIONS

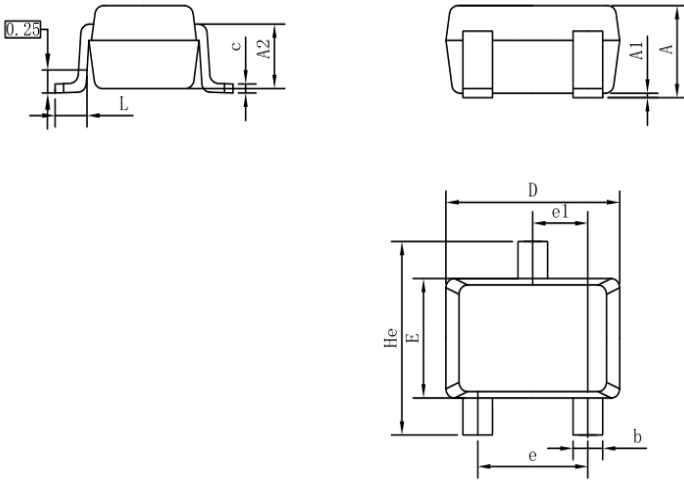

SOT-323			
DIM	MIN	NOR	MAX
A	0.80	0.95	1.00
A1	0.00	0.05	0.10
A2	0.7 REF		
b	0.30	0.35	0.40
c	0.10	0.15	0.25
D	1.80	2.05	2.20
E	1.15	1.30	1.35
e	1.20	1.30	1.40
e1	0.65 BSC		
L	0.20	0.35	0.56
He	2.00	2.10	2.40
ALL Dimension in mm			

8.SOLDERING FOOTPRINT

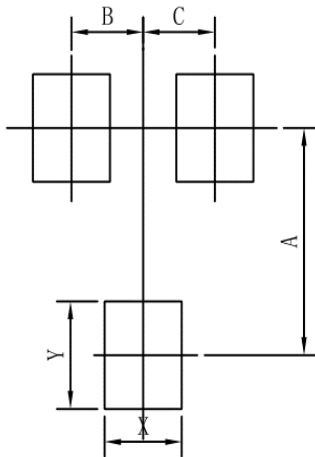

SOT-323	
DIM	MIN
A	1.90
B	0.65
C	0.65
X	0.70
Y	0.90

