

General Purpose Transistors

PNP Silicon

FEATURE

- Simplifies Circuit Design.
- We declare that the material of product compliance with RoHS requirements.
- S- Prefix for Automotive and Other Applications Requiring Unique Site and Control Change Requirements; AEC-Q101 Qualified and PPAP Capable.

ORDERING INFORMATION

Device	Marking	Shipping
MBT3906T	2A	3000/Tape & Reel
S-MBT3906T	2A	3000/Tape & Reel

MAXIMUM RATINGS

Rating	Symbol	Value	Unit
Collector–Emitter Voltage	V_{CEO}	- 40	Vdc
Collector–Base Voltage	V_{CBO}	- 40	Vdc
Emitter–Base Voltage	V_{EBO}	- 5.0	Vdc
Collector Current — Continuous	I_C	- 200	mAdc

THERMAL CHARACTERISTICS

Characteristic	Symbol	Max	Unit
Total Device Dissipation FR– 4 Board(1) $T_A = 25^\circ\text{C}$	P_D	200	mW
Derate above 25°C		1.6	mW/ $^\circ\text{C}$
Thermal Resistance Junction to Ambient	$R_{\theta JA}$	600	$^\circ\text{C}/\text{W}$
Total Device Dissipation FR-4 Board (2), $T_A = 25^\circ\text{C}$	P_D	300	mW
Derate above 25°C		2.4	mW/ $^\circ\text{C}$
Thermal Resistance Junction to Ambient	$R_{\theta JA}$	400	$^\circ\text{C}/\text{W}$
Junction and Storage Temperature	T_J, T_{stg}	-55 to +150	$^\circ\text{C}$

DEVICE MARKING

MBT3906T = 2A

ELECTRICAL CHARACTERISTICS ($T_A = 25^\circ\text{C}$ unless otherwise noted)

Characteristic	Symbol	Min	Max	Unit
----------------	--------	-----	-----	------

OFF CHARACTERISTICS

Collector–Emitter Breakdown Voltage (3) ($I_C = -1.0\text{ mAdc}, I_B = 0$)	$V_{(BR)CEO}$	- 40	—	Vdc
Collector–Base Breakdown Voltage ($I_C = -10\ \mu\text{Adc}, I_E = 0$)	$V_{(BR)CBO}$	- 40	—	Vdc
Emitter–Base Breakdown Voltage ($I_E = -10\ \mu\text{Adc}, I_C = 0$)	$V_{(BR)EBO}$	- 5.0	—	Vdc
Base Cutoff Current ($V_{CE} = -30\text{ Vdc}, V_{EB} = -3.0\text{ Vdc}$)	I_{BL}	—	- 50	nAdc
Collector Cutoff Current ($V_{CE} = -30\text{ Vdc}, V_{EB} = -3.0\text{ Vdc}$)	I_{CEX}	—	- 50	nAdc

1. FR-4 Minimum Pad.
2. FR-4 1.0 x 1.0 Inch Pad.

MBT3906T

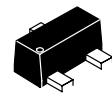

SOT-523

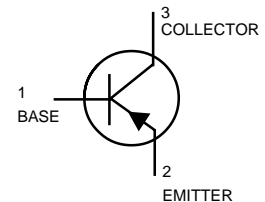

ELECTRICAL CHARACTERISTICS ($T_A = 25^\circ\text{C}$ unless otherwise noted) (Continued)

Characteristic	Symbol	Min	Max	Unit
ON CHARACTERISTICS (3)				
DC Current Gain ($I_C = -0.1\text{ mAdc}$, $V_{CE} = -1.0\text{ Vdc}$)	h_{FE}	60	—	—
($I_C = -1.0\text{ mAdc}$, $V_{CE} = -1.0\text{ Vdc}$)		80	—	
($I_C = -10\text{ mAdc}$, $V_{CE} = -1.0\text{ Vdc}$)		100	300	
($I_C = -50\text{ mAdc}$, $V_{CE} = -1.0\text{ Vdc}$)		60	—	
($I_C = -100\text{ mAdc}$, $V_{CE} = -1.0\text{ Vdc}$)		30	—	
Collector–Emitter Saturation Voltage ($I_C = -10\text{ mAdc}$, $I_B = -1.0\text{ mAdc}$)	$V_{CE(sat)}$	—	-0.25	Vdc
($I_C = -50\text{ mAdc}$, $I_B = -5.0\text{ mAdc}$)		—	-0.4	
Base–Emitter Saturation Voltage ($I_C = -10\text{ mAdc}$, $I_B = -1.0\text{ mAdc}$)	$V_{BE(sat)}$	-0.65	-0.85	Vdc
($I_C = -50\text{ mAdc}$, $I_B = -5.0\text{ mAdc}$)		—	-0.95	

SMALL-SIGNAL CHARACTERISTICS

Current–Gain — Bandwidth Product ($I_C = -10\text{ mAdc}$, $V_{CE} = -20\text{ Vdc}$, $f = 100\text{ MHz}$)	f_T	250	—	MHz
Output Capacitance ($V_{CB} = -5.0\text{ Vdc}$, $I_E = 0$, $f = 1.0\text{ MHz}$)	C_{obo}	—	4.5	pF
Input Capacitance ($V_{EB} = -0.5\text{ Vdc}$, $I_C = 0$, $f = 1.0\text{ MHz}$)	C_{ibo}	—	10	pF
Input Impedance ($V_{CE} = -10\text{ Vdc}$, $I_C = -1.0\text{ mAdc}$, $f = 1.0\text{ kHz}$)	h_{ie}	2.0	12	k Ω
Voltage Feedback Ratio ($V_{CE} = -10\text{ Vdc}$, $I_C = -1.0\text{ mAdc}$, $f = 1.0\text{ kHz}$)	h_{re}	0.1	10	$\times 10^{-4}$
Small–Signal Current Gain ($V_{CE} = -10\text{ Vdc}$, $I_C = -1.0\text{ mAdc}$, $f = 1.0\text{ kHz}$)	h_{fe}	100	400	—
Output Admittance ($V_{CE} = -10\text{ Vdc}$, $I_C = -1.0\text{ mAdc}$, $f = 1.0\text{ kHz}$)	* h_{oe}	3.0	60	μmhos
Noise Figure ($V_{CE} = -5.0\text{ Vdc}$, $I_C = -100\text{ }\mu\text{A}$, $R_S = 1.0\text{ k}\Omega$, $f = 1.0\text{ kHz}$)	NF	—	4.0	dB

SWITCHING CHARACTERISTICS

Delay Time	($V_{CC} = -3.0\text{ Vdc}$, $V_{BE} = 0.5\text{ Vdc}$, $I_C = -10\text{ mAdc}$, $I_{B1} = -1.0\text{ mAdc}$)	t_d	—	35	ns
Rise Time		t_r	—	35	
Storage Time	($V_{CC} = -3.0\text{ Vdc}$, $I_C = -10\text{ mAdc}$, $I_{B1} = I_{B2} = -1.0\text{ mAdc}$)	t_s	—	225	ns
Fall Time		t_f	—	75	

3. Pulse Test: Pulse Width $\leq 300\text{ }\mu\text{s}$; Duty Cycle $\leq 2.0\%$.



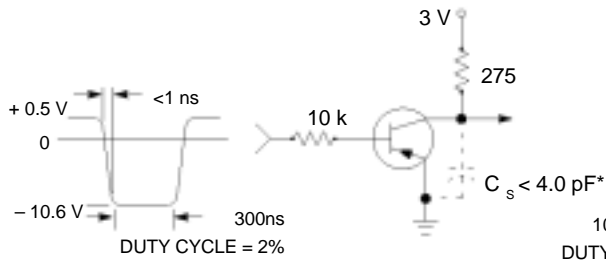

**Figure 1. Delay and Rise Time
Equivalent Test Circuit**

*Total shunt capacitance of test jig and connectors

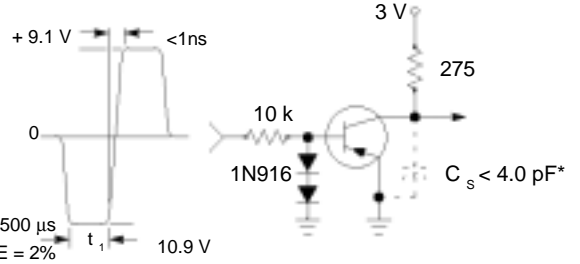

**Figure 2. Storage and Fall Time
Equivalent Test Circuit**

TYPICAL TRANSIENT CHARACTERISTICS

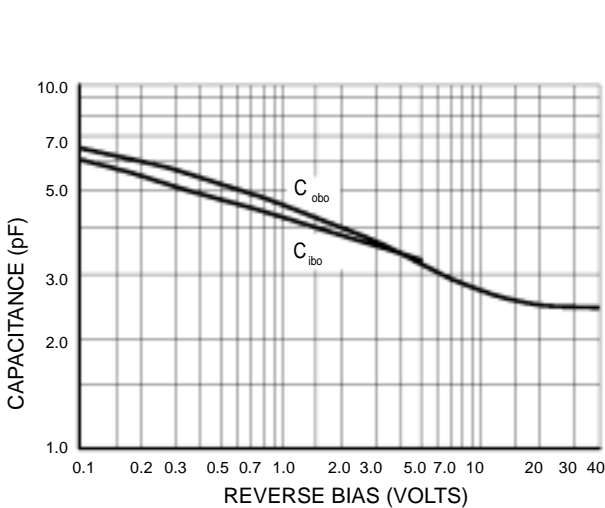

Figure 3. Capacitance

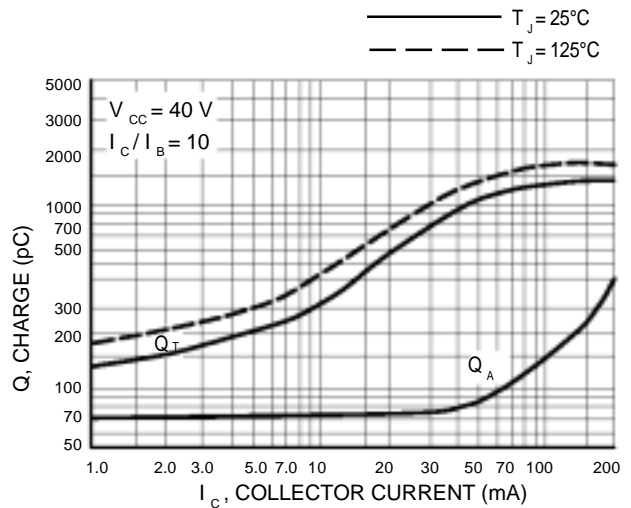

Figure 4. Charge Data

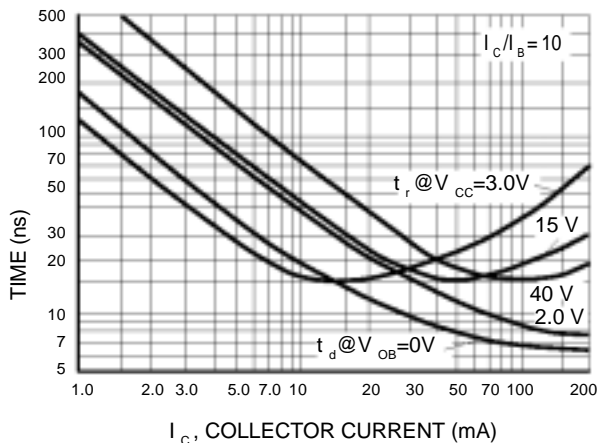

Figure 5. Turn-On Time

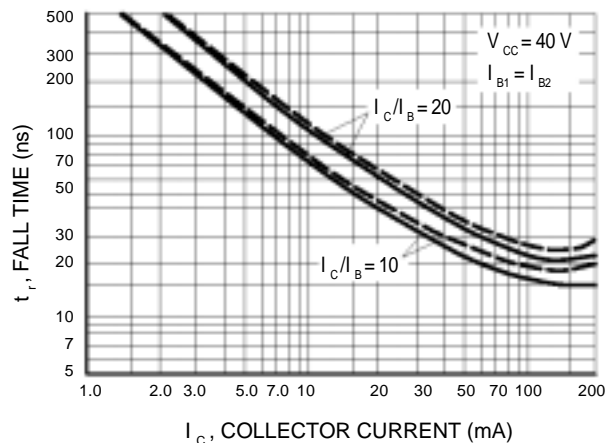

Figure 6. Fall Time



**TYPICAL AUDIO SMALL-SIGNAL CHARACTERISTICS
NOISE FIGURE VARIATIONS**

($V_{CE} = -5.0$ Vdc, $T_A = 25^\circ\text{C}$, Bandwidth = 1.0 Hz)

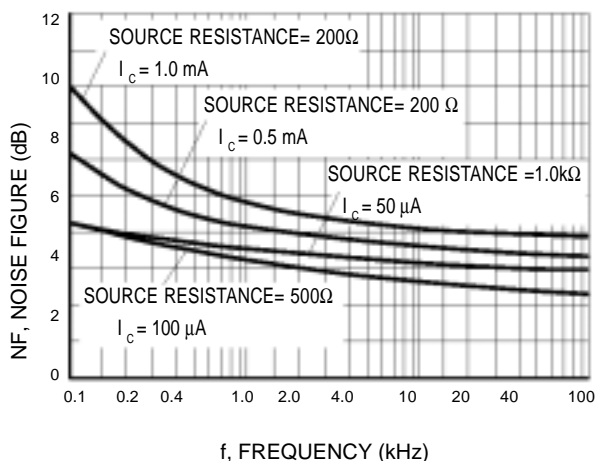

Figure 7. Noise Figure

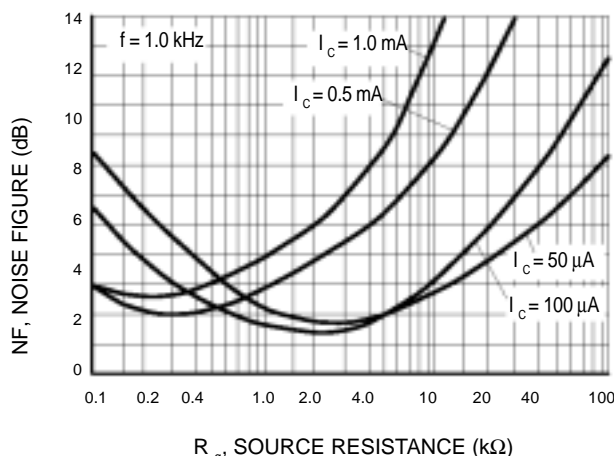

Figure 8. Noise Figure

h PARAMETERS

($V_{CE} = 10$ Vdc, $f = 1.0$ kHz, $T_A = 25^\circ\text{C}$)

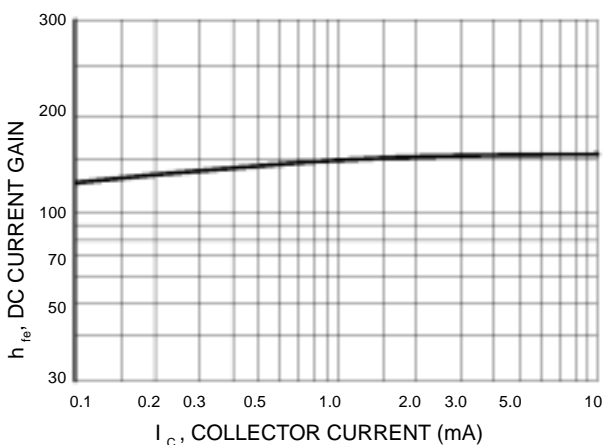

Figure 9. Current Gain

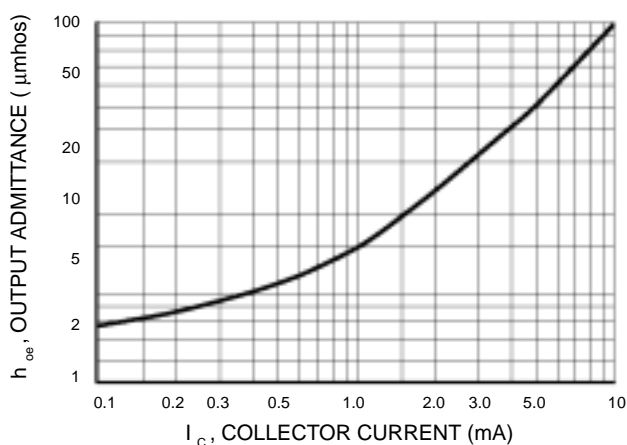

Figure 10. Output Admittance

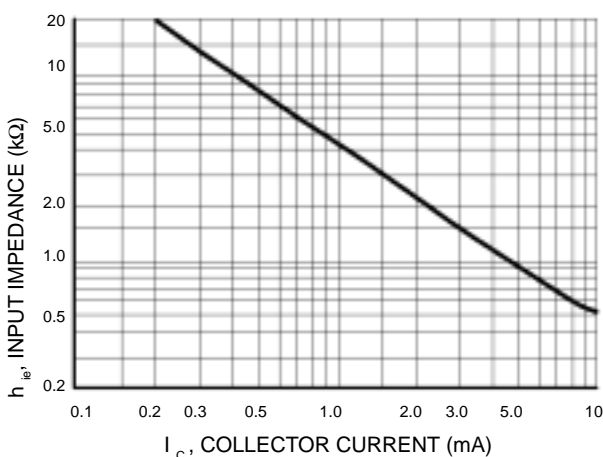

Figure 11. Input Impedance

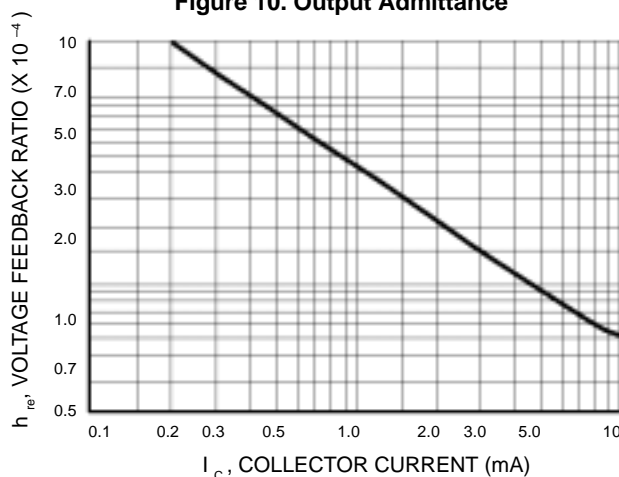

Figure 12. Voltage Feedback Ratio



TYPICAL STATIC CHARACTERISTICS

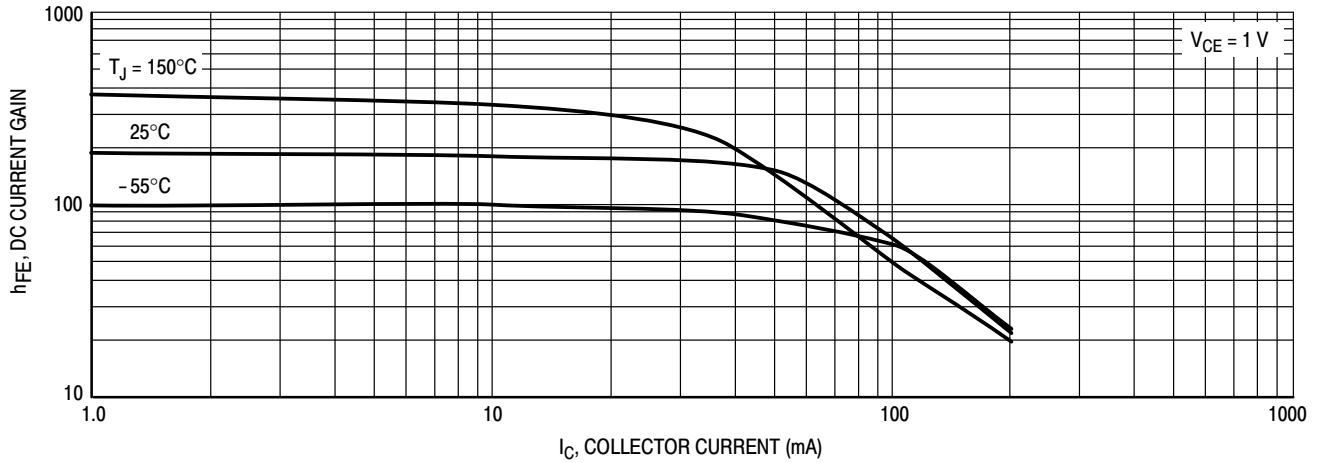

Figure 13. DC Current Gain

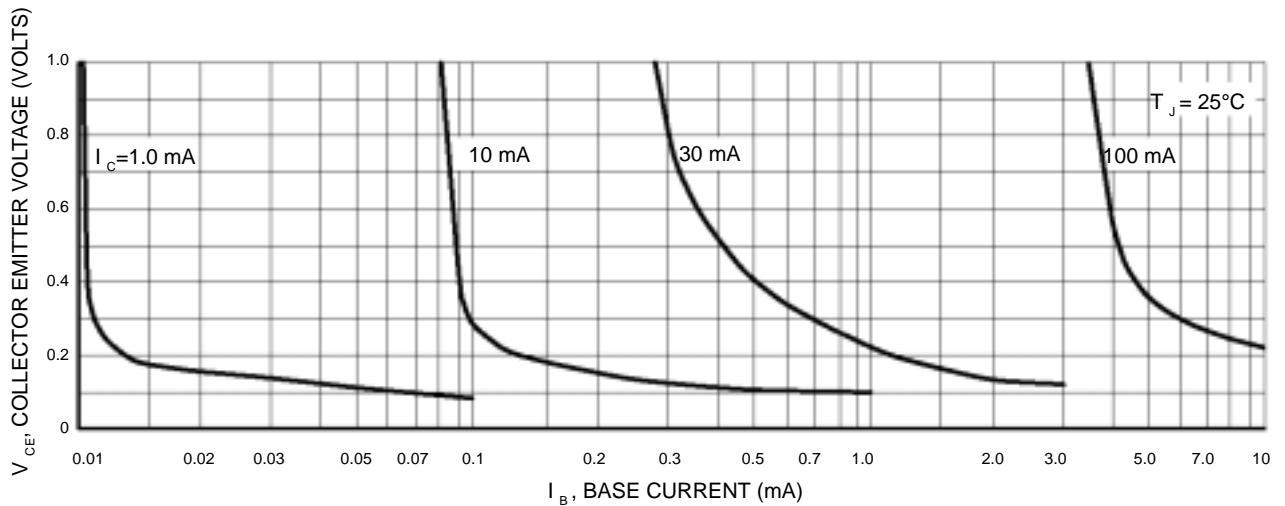

Figure 14. Collector Saturation Region

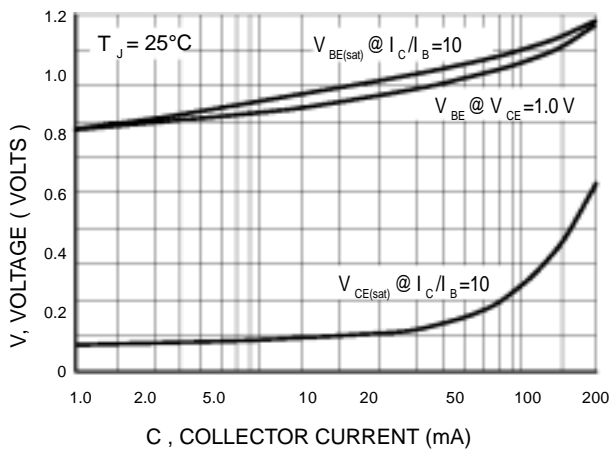

Figure 15. "ON" Voltages

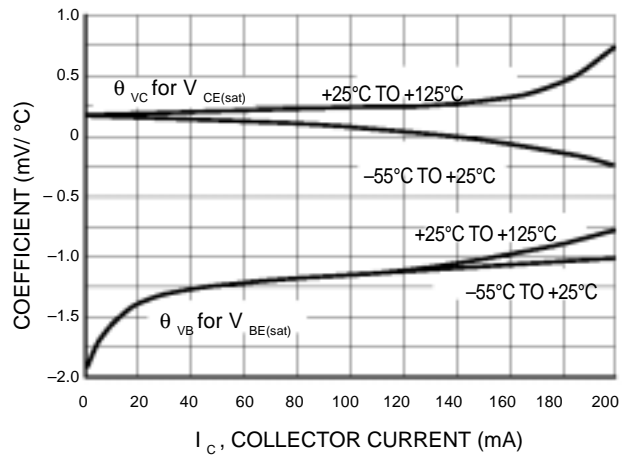
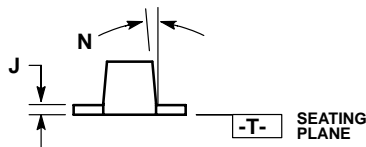
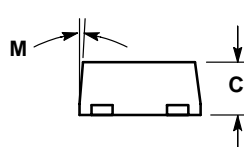
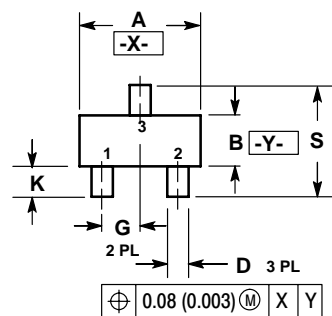

Figure 16. Temperature Coefficients



SOT-523



NOTES:

1. DIMENSIONING AND TOLERANCING PER ANSI Y14.5M, 1982.
2. CONTROLLING DIMENSION: MILLIMETERS
3. MAXIMUM LEAD THICKNESS INCLUDES LEAD FINISH THICKNESS. MINIMUM LEAD THICKNESS IS THE MINIMUM THICKNESS OF BASE MATERIAL.
4. 463C-01 OBSOLETE, NEW STANDARD 463C-02.

DIM	MILLIMETERS			INCHES		
	MIN	NOM	MAX	MIN	NOM	MAX
A	1.50	1.60	1.70	0.059	0.063	0.067
B	0.75	0.85	0.95	0.030	0.034	0.040
C	0.60	0.70	0.80	0.024	0.028	0.031
D	0.23	0.28	0.33	0.009	0.011	0.013
G	0.50 BSC			0.020 BSC		
H	0.53 REF			0.021 REF		
J	0.10	0.15	0.20	0.004	0.006	0.008
K	0.30	0.40	0.50	0.012	0.016	0.020
L	1.10 REF			0.043 REF		
M	---	---	10 °	---	---	10 °
N	---	---	10 °	---	---	10 °
S	1.50	1.60	1.70	0.059	0.063	0.067

