

BC847AN

S-BC847AN

General Purpose Transistors NPN Silicon

1. FEATURES

- Moisture Sensitivity Level: 1
- ESD Rating – Human Body Model: >4000 V
– Machine Model: >400 V
- We declare that the material of product compliance with RoHS requirements and Halogen Free.
- S- prefix for automotive and other applications requiring unique site and control change requirements; AEC-Q101 qualified and PPAP capable.

2. DEVICE MARKING AND ORDERING INFORMATION

Device	Marking	Shipping
BC847AN	1E	10000/Tape&Reel

3. MAXIMUM RATINGS(Ta = 25°C)

Parameter	Symbol	Limits	Unit
Collector–Emitter Voltage	V _{CEO}	45	V
Collector–Base Voltage	V _{CBO}	50	V
Emitter–Base Voltage	V _{EB0}	6	V
Collector Current — Continuous	I _C	100	mA

4. THERMAL CHARACTERISTICS

Parameter	Symbol	Limits	Unit
Total Device Dissipation, FR-5 Board (Note 1) @ TA = 25°C Derate above 25°C	PD	250 2	mW mW/°C
Thermal Resistance, Junction–to–Ambient(Note 1)	R _{θJA}	500	°C/W
Junction and Storage temperature	T _J , T _{stg}	-55 ~ +150	°C

1. FR-5 = 1.0 x 0.75 x 0.062 in.

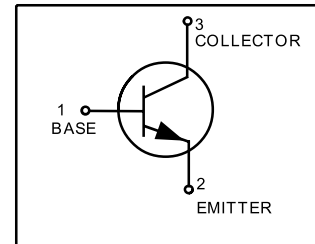

5. ELECTRICAL CHARACTERISTICS (Ta= 25°C)

OFF CHARACTERISTICS

Characteristic	Symbol	Min.	Typ.	Max.	Unit
Collector–Emitter Breakdown Voltage (IC = 10 mA)	VBR(CEO)	45	-	-	V
Collector–Emitter Breakdown Voltage (IC = 10 μ A, VEB = 0)	VBR(CES)	50	-	-	V
Collector–Base Breakdown Voltage (IC = 10 μ A)	VBR(CBO)	50	-	-	V
Emitter–Base Breakdown Voltage (IE = 1.0 μ A)	VBR(EBO)	6	-	-	V
Collector Cutoff Current (VCB = 30 V)	ICBO	-	-	15	nA
(VCB = 30 V, TA = 150°C)		-	-	5	μ A

ON CHARACTERISTICS

DC Current Gain (IC = 2.0 mA, VCE = 5.0 V)	HFE	110	180	220	
Collector–Emitter Saturation Voltage (IC = 10 mA, IB = 0.5 mA)	VCE(sat)	-	-	0.25	V
(IC = 100 mA, IB = 5.0 mA)		-	-	0.4	
Base–Emitter Saturation Voltage (IC = 10 mA, IB = 0.5 mA)	VBE(sat)	-	0.7	-	V
(IC = 100 mA, IB = 5.0 mA)		-	0.9	-	
Base–Emitter Voltage (IC = 2.0 mA, VCE = 5.0 V)	VBE(on)	580	660	700	mV
(IC = 10 mA, VCE = 5.0 V)		-	-	770	

SMALL–SIGNAL CHARACTERISTICS

Current–Gain — Bandwidth Product (IC = 10 mA, VCE = 5.0 V, f = 100 MHz)	fT	100	-	-	MHz
Output Capacitance (VCB = 10 V, f = 1.0 MHz)	Cobo	-	-	4.5	pF
Noise Figure (IC = 0.2 mA, VCE = 5.0 V, RS = 2.0 k Ω f = 1.0 kHz, BW = 200 Hz)	NF	-	-	10	dB



6.ELECTRICAL CHARACTERISTICS CURVES

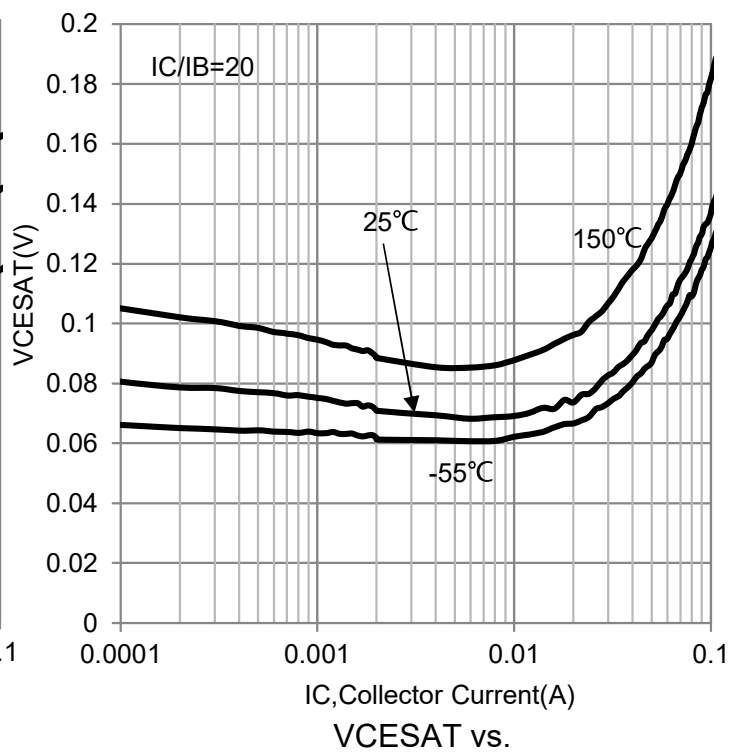
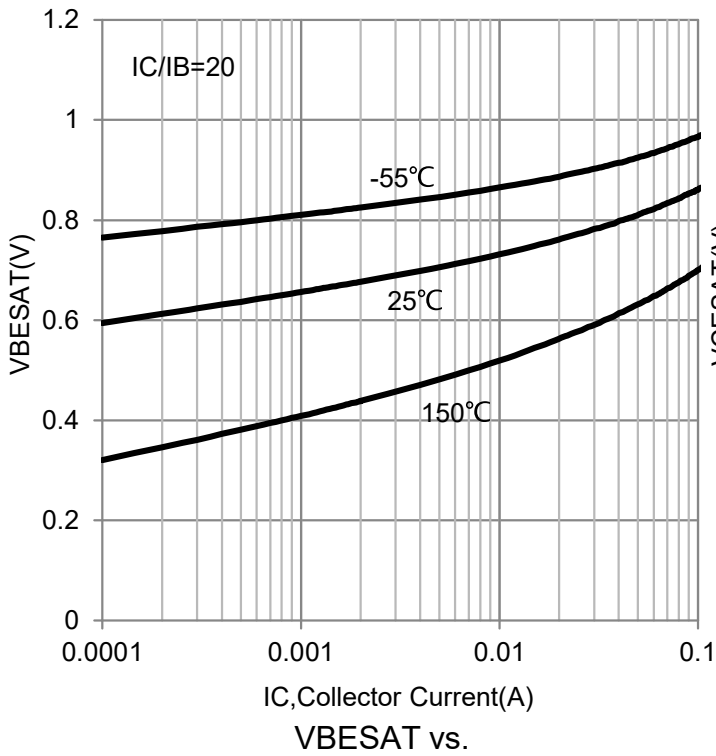
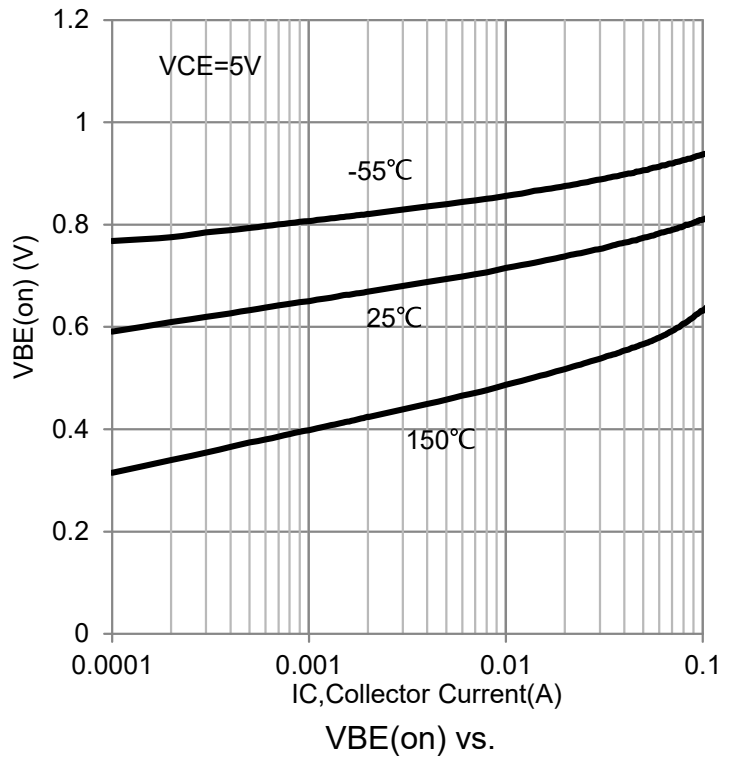
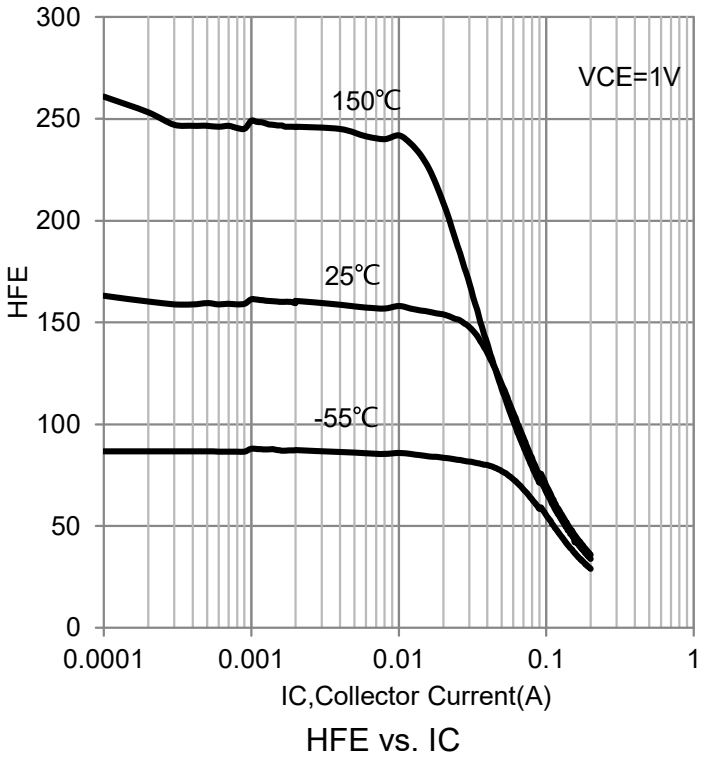

6.ELECTRICAL CHARACTERISTICS CURVES(Con.)

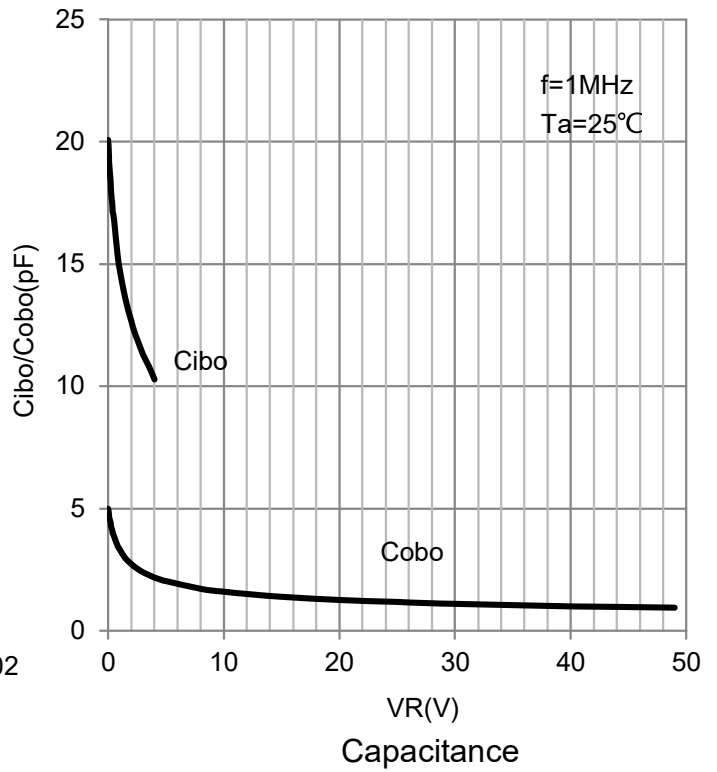
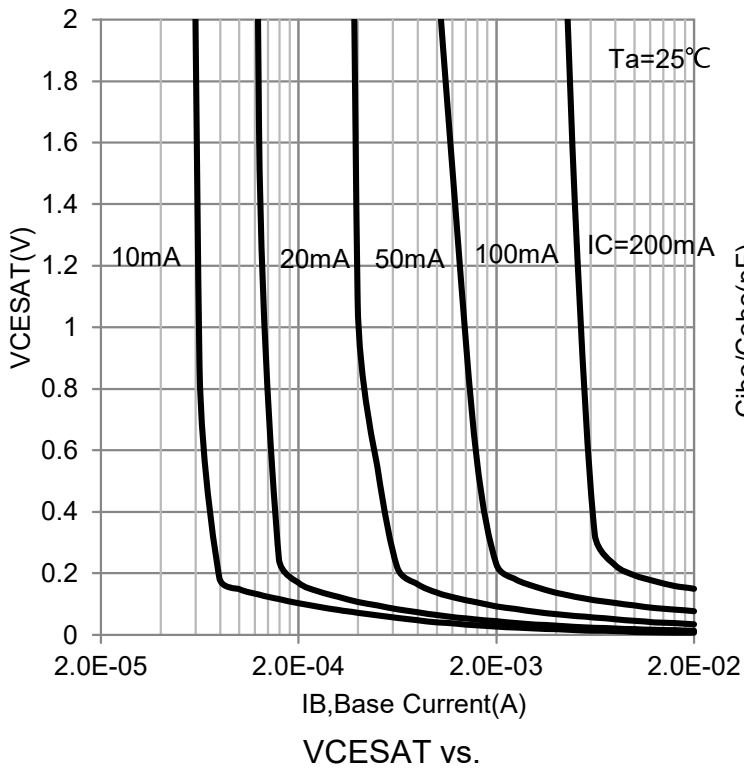

7. OUTLINE AND DIMENSIONS

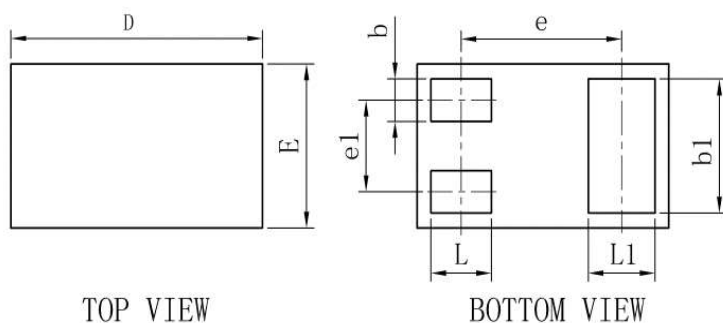

TOP VIEW

BOTTOM VIEW

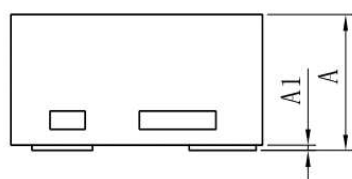

SIDE VIEW

DFN1006-3L			
DIM	MIN	TYP	MAX
D	0.95	1.00	1.05
E	0.55	0.60	0.65
e	-	0.64	-
e1	-	0.34	-
L	0.19	0.24	0.29
L1	0.22	0.27	0.32
b	0.10	0.15	0.20
b1	0.44	0.49	0.54
A	0.43	0.48	0.53
A1	0	-	0.05
All Dimensions in mm			

8. SOLDERING FOOTPRINT

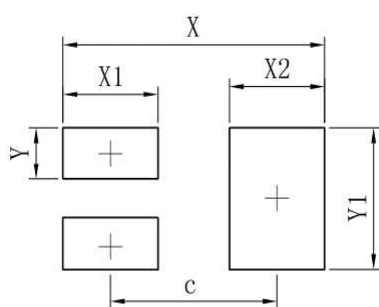

Dimensions	(mm)
c	0.70
X	1.10
X1	0.40
X2	0.40
Y	0.20
Y1	0.55

